



# Plum 360™ Infuser

System Operating Manual

For use with all configurations  
of list number **REF** 30010

Compatible with:  
ICU Medical MedNet™

IFU0000140 (02, 2020-06)

**icumedical**  
human connections

---

---

# Notes

---

---

# Change History

<b>Part Number</b>	<b>Description of Change</b>
IFU0000140 (02, 2020-06)	Updated Sections 1, 4, and 12 to reflect that the use of a syringe adapter is required for syringes 3-10mL to ensure delivery accuracy and reduce proximal occlusion alarms.

---

---

# Notes

---

---

# Contents

<b>Section 1, Introduction</b> . . . . .	<b>1-1</b>
Reporting Serious Incidents . . . . .	1-2
Intended Use . . . . .	1-2
Training . . . . .	1-2
Conventions . . . . .	1-3
Illustrations, Screen Displays, and Software Messages .	1-4
Labeling Symbols Glossary . . . . .	1-5
Definitions . . . . .	1-8
Precautions . . . . .	1-14
Warnings, Cautions, and Guidelines . . . . .	1-14
General Warnings and Cautions . . . . .	1-14
Piggyback, Concurrent, and Secondary Delivery Guidelines . . . . .	1-16
Guidelines When Opening the Cassette Door . . . . .	1-18
Administration Sets and Accessories Guidelines . . . . .	1-19
Precautions to Avoid Unintended Bolus . . . . .	1-20
Guidelines to Avoid Air in the Patient Line . . . . .	1-21
Guidelines During Backpriming . . . . .	1-21
Battery Guidelines . . . . .	1-22
Guidelines During Cleaning . . . . .	1-22
Artifacts . . . . .	1-23
Interconnecting of Medical Equipment . . . . .	1-25
Electromagnetic Compatibility . . . . .	1-25
FCC Information . . . . .	1-28
US FCC (Federal Communications Commission) Statement (United States Only) . . . . .	1-28
FCC Interference Statement (United States Only) . . . . .	1-28
Department of the Minister of Innovation, Science, and Economic Development (Canada Only) . . . . .	1-29
Radio Frequency Exposure Statement . . . . .	1-29
FCC Rules, Part 15/Industry Canada . . . . .	1-29
Radio Equipment Directive . . . . .	1-30
RoHS . . . . .	1-31
Taiwan NCC Warning Statement . . . . .	1-31

Suspected Cybersecurity Event or Threat . . . . . 1-32

**Section 2, Equipment Description . . . . . 2-1**

Keypad and Display . . . . . 2-2  
    Alphanumeric Keypad . . . . . 2-2  
    Numeric Keypad . . . . . 2-3  
Operating Keys . . . . . 2-4  
Indicators . . . . . 2-7  
Display Symbols . . . . . 2-7  
CE Module . . . . . 2-10  
Pole Clamp, Potential Equalization Terminal, and  
    Power Cord . . . . . 2-12  
Plum Administration Sets . . . . . 2-14  
    The Plum Cassette . . . . . 2-15  
    Other Administration Set Features . . . . . 2-18

**Section 3, Basic Operations . . . . . 3-1**

Mounting the Infuser on an I.V. Pole . . . . . 3-3  
    Mounting Multiple Infusers to an I.V. Pole . . . . . 3-4  
Attaching a Nurse Call Interface Cable . . . . . 3-4  
Opening the Cassette Door . . . . . 3-5  
Opening the Cassette Door Completely . . . . . 3-7  
Closing the Cassette Door . . . . . 3-9  
Turning Power On . . . . . 3-10  
Turning Power Off . . . . . 3-12  
Viewing the Display . . . . . 3-12  
Using the Keypad and Controls . . . . . 3-12  
    Using the Keypad to Enter Program Information . . . . . 3-13  
    Silencing the Keypad . . . . . 3-13  
    Locking and Unlocking the Keypad . . . . . 3-13  
    Using the Keypad to Search the Drug List . . . . . 3-16  
Working with Alarms . . . . . 3-18  
    Test the Alarm System . . . . . 3-18  
    Responding to an Alarm . . . . . 3-19  
    Adjusting the Audio Alarm Volume . . . . . 3-20  
    Programming a Callback Alarm . . . . . 3-20  
    Restarting the Delivery Automatically After a

Distal Occlusion Alarm . . . . .	3-20
Stopping and Restarting a Delivery . . . . .	3-22
Clearing a Line . . . . .	3-23
Setting the Post Infusion Rate . . . . .	3-24
Post Infusion Rate (Loading Dose Delivery and Multistep Delivery). . . . .	3-27
Viewing and Clearing the Volumes Infused. . . . .	3-27
Adjusting Display Lighting and Contrast . . . . .	3-30
Viewing CCA and Infuser Settings . . . . .	3-31
CCA/Infuser Setting Descriptions . . . . .	3-33
Changing the Default Infuser Settings. . . . .	3-37
Setting the Distal Pressure Alarm Limit. . . . .	3-37
Changing the Default Line B Delivery Mode. . . . .	3-39
<b>Section 4, Plum Administration Sets . . . . .</b>	<b>4-1</b>
Priming a Primary Administration Set . . . . .	4-2
Loading a Cassette. . . . .	4-8
Preparing a Secondary Delivery from an Administration Set. . . . .	4-10
Connecting a Secondary Line or Syringe. . . . .	4-13
Connecting to a Clave Port . . . . .	4-14
Connecting to a Pierced Port. . . . .	4-16
Connecting to a Capped Port. . . . .	4-18
Priming the Syringe Adapter . . . . .	4-19
Preparing a Secondary Delivery from a Syringe . . . . .	4-19
Backpriming. . . . .	4-21
Preparing to Backprime . . . . .	4-22
Backpriming Procedure . . . . .	4-23
Discontinuing Electronic Flow Control and Setting Gravity Flow. . . . .	4-25
Removing a Secondary Line or Syringe . . . . .	4-27
Discontinuing Fluid Administration . . . . .	4-28
Changing Administration Sets . . . . .	4-29
Resolving a Distal Air-in-Line Alarm . . . . .	4-30
Avoiding Unintended Bolus While Resolving a Distal Occlusion. . . . .	4-31

**Section 5, Programming . . . . .5-1**

- Programming Features Common to the Default Drug
  - Library and Custom Drug Libraries . . . . .5-1
  - Auto-Calculations . . . . .5-1
  - Body Surface Area (BSA) Dosing Unit . . . . .5-1
  - Programming Line B . . . . .5-2
  - Clearing Line Settings . . . . .5-9
- Programming with a Default Drug Library . . . . .5-9
  - Programming Without a Drug List . . . . .5-10
- Programming with a Drug List . . . . .5-10
- Programming with a Custom Drug Library . . . . .5-11
  - Hard Limits . . . . .5-13
  - Soft Limits . . . . .5-13
  - Changing a CCA from the Drug List Screen . . . . .5-13
  - Delaying a Line . . . . .5-14
  - Putting a Line in Standby – A/B Delivery Screen . . . . .5-14
  - Putting a Line in Standby – Confirmation Screen . . . . .5-14
  - Putting a Line in Standby – Piggyback Mode . . . . .5-15
  - Canceling Standby – Piggyback Mode . . . . .5-15
- Nurse Callback . . . . .5-15

**Section 6, Auto-Programming . . . . .6-1**

- Auto-Programming the Plum 360 Infuser . . . . .6-2

**Section 7, Additional Features . . . . .7-1**

- Delay a Line . . . . .7-1
- Standby . . . . .7-1
  - Put 1 or 2 Lines in Standby from the Delivery Screen (Non-Piggyback) . . . . .7-2
  - Cancel Standby for 1 or 2 Lines from the Delivery Screen (Non-Piggyback) . . . . .7-2
  - Put Piggyback Mode in Standby . . . . .7-3
  - Cancel Piggyback Mode Standby . . . . .7-3
- Examples of Automatic Calculation . . . . .7-4
  - mL/hr – Initial Programming . . . . .7-4
  - mL/hr – After VTBI Complete Alarm . . . . .7-4



Non-Time-Based Dose Calculation (for example, mL) - Initial Programming . . . . .	7-5
Non-Time-Based Dose Calculation (for example, mL) - After VTBI Complete Alarm. . . . .	7-5
Time-Based Dose Calculation (for example, mg/min) - Initial Programming . . . . .	7-6
Time-Based Dose Calculation (for example, mg/min) - After VTBI Complete Alarm. . . . .	7-7
Recalculation Alert When Titrating a Confirmed mL/hr or Non-Time-Based Dosing Unit . . . . .	7-7
<b>Section 8, Delivery Options . . . . .</b>	<b>8-1</b>
Programming a Bolus Dose. . . . .	8-1
Programming a Loading Dose. . . . .	8-4
Programming a Multistep Delivery. . . . .	8-6
Adding a Step to a Multistep Delivery. . . . .	8-8
Adding VTBI to Loading Dose or Multistep Program After VTBI Complete Alarm Activates. . . . .	8-9
Titration . . . . .	8-11
Loading Dose Delivery and Multistep Delivery. . . . .	8-11
Changing the CCA During Infusion . . . . .	8-11
<b>Section 9, Alarms and Troubleshooting . . . . .</b>	<b>9-1</b>
Alarm Priority Levels . . . . .	9-1
General Alarms. . . . .	9-2
High Priority Alarms. . . . .	9-2
Medium Priority Alarms . . . . .	9-6
Low Priority Alarms . . . . .	9-7
Line A Alarms. . . . .	9-9
High Priority Alarms. . . . .	9-9
Medium Priority Alarms. . . . .	9-11
Line B Alarms. . . . .	9-13
High Priority Alarms. . . . .	9-13
Medium Priority Alarms. . . . .	9-17
Lines A and B Alarms. . . . .	9-19
High Priority Alarms. . . . .	9-19

Rejected Auto-Programs . . . . .	9-25
Partially Programmed Line . . . . .	9-29
Invalid Titration . . . . .	9-29

**Section 10, Cleaning, Maintenance, Storage,  
and Service . . . . .10-1**

Cleaning the Infuser . . . . .	10-1
Cleaning Procedure . . . . .	10-2
Cleaning Supplies . . . . .	10-3
Infuser Maintenance . . . . .	10-4
Battery Maintenance . . . . .	10-4
Storage . . . . .	10-5
Service . . . . .	10-6

**Section 11, Specifications . . . . .11-1**

Physical . . . . .	11-1
Electrical . . . . .	11-2
Connectivity Engine . . . . .	11-4
VTBI Range . . . . .	11-6
Delivery Rate Range and Duration . . . . .	11-6
Air-in-Line Alarm . . . . .	11-6
Occlusion Alarm and Limits . . . . .	11-6
Time To Detect Downstream Occlusions . . . . .	11-8
Maximum Unintended Bolus Volume Released After Distal Occlusion is Resolved . . . . .	11-9
Delivery Accuracy . . . . .	11-10
Bolus Delivery Accuracy . . . . .	11-11
Enteral or High Viscosity Fluids Effects . . . . .	11-11
Trumpet Curves . . . . .	11-12
Example . . . . .	11-13

**Section 12, Supplies and Accessories . . . . .12-1**

Administration Sets . . . . .	12-1
CE Marked Administration Sets . . . . .	12-1
Non-CE Marked Administration Sets . . . . .	12-3

Administration Fluids .....	12-6
Containers .....	12-6
Accessories .....	12-7
Tandem Carrier .....	12-7
Multiple Device Adapter .....	12-9
I.V. Pole .....	12-11
T-bar Accessory .....	12-13
I.V. Mini-Pole .....	12-15
ICU Medical MedNet Safety Software .....	12-16
Loss of Communication .....	12-17
<b>Section 13, Warranty .....</b>	<b>13-1</b>
<b>Section 14, CCAs and Drug Libraries .....</b>	<b>14-1</b>
DDL CCA and Drug List .....	14-1
Custom Drug Library (CDL) .....	14-9
Dosing Units and Allowable Ranges .....	14-10
Patient Data Limits .....	14-12

---

---

# Notes

---

---

---

## Section 1

# Introduction

---

The Plum 360™ is a large volume infuser capable of delivering fluids for a variety of therapies such as parenteral, enteral, or epidural infusions. The Plum 360 infuser can deliver fluids over a broad range of infusion rates and is capable of concurrent delivery from one or more rigid or flexible fluid containers.

The Plum 360 infuser features an innovative design that automates many aspects of concurrent, secondary, and piggyback infusions. A positive valving cassette allows two lines to be delivered at independent rates and prevents free flow conditions. The volume to be infused (VTBI) is delivered through one line to a patient. The two lines can be delivered in Concurrent mode (together) or Piggyback mode (one after another) without raising or lowering I.V. bags. The infuser also allows the clinician to program a bolus dose from either line.

The infuser has an IPX2 rating and includes a ratcheting pole clamp to prevent over-tightening, proximal tubing guides to help prevent tubing kinks that can lead to proximal occlusions, and a tilted display for improved readability.

The Plum 360 infuser also enables fluid pathway troubleshooting such as removing proximal air in line, without disconnecting the patient line.

The Plum 360 can act as a standalone infuser, or in conjunction with the ICU Medical MedNet™ software to provide medication safety software at the point of care, with customized drug libraries to support hospital defined protocols by clinical care area. In such a configuration, the Plum 360 infuser can communicate with systems on the network via Ethernet or state of the art wireless communication using an 802.11 a/b/g/n/, 2.4 GHz/5 GHz dual-band radio.

The Plum 360 infuser and ICU Medical MedNet software interface with other hospital systems such as Electronic Health Records, Electronic Medication Administration Records, Bar Code Point of Care, Real Time Location Services, and other systems designed to

create efficiency and consistency in managing patient information and clinical workflows.

Each infuser includes a Connectivity Engine (CE) which provides both wired Ethernet and wireless 802.11 a/b/g/n networking capabilities. The Plum 360 infuser interfaces with ICU Medical MedNet application software to download drug library and infuser software updates and enable auto-programming of the infuser.

The Plum 360 infuser is fully compatible with Plum™ Series administration sets and accessories, and the CLAVE™ needleless connection systems, providing a convenient and cost-effective infuser.

## Reporting Serious Incidents

Serious incidents associated with the use of this product should be reported to:

- ICU Medical using the “Contact Us” link at [www.icumed.com](http://www.icumed.com), and
- the relevant regulatory/competent authority of the country in which the user and/or patient is established (where required).

## Intended Use

The Plum 360 infuser is intended for parenteral, enteral, and epidural therapies and the administration of whole blood and blood products.

The Plum 360 infuser is intended for use in clinical environments at the direction or under the supervision of licensed physicians or certified healthcare professionals who are trained in the use of the infuser and the administration of parenteral, enteral, and epidural therapies and the administration of whole blood and blood products.

## Training

ICU Medical offers a complete range of training and education to help new users and experienced personnel acquire the knowledge and confidence to operate the Plum infuser properly and efficiently.

Training is available at the time of infuser purchase. Supplemental training can be purchased throughout the infuser's service life. Training content is tailored to the needs of the medical facility and is presented by clinical personnel. ICU Medical works with hospital staff to identify training needs, including duration and frequency of training. Training is mandatory for new device implementation.

Contact your ICU Medical Representative for more information about available training programs.

## Conventions

This section describes the conventions used throughout this manual, as follows:

Convention	Application	Example
<i>Italic</i>	Function or mode specific instructions, or disclaimer	<i>Primary Only:</i> Attach an empty container.
<i>Italic, bold, blue</i>	Reference to a section, figure, or table	(See <b>Adjusting the Audio Alarm Volume</b> on page 3-20)
[BRACKETED ALL CAPS]	Keys on the device are displayed in [BRACKETED ALL CAPS] or with a graphic.	[START] or 
▲[Bracketed Blue]	Softkey Options	▲[Choose]
Initial Caps lowercase	Screen displays and device labels (as appropriate)	Program Dose Calculation
<b>Bold</b>	Emphasis	...sets are supplied <b>Sterile</b> and are for....



### **WARNING**

---

**A WARNING MESSAGE CONTAINS SPECIAL SAFETY EMPHASIS AND MUST BE OBSERVED AT ALL TIMES. FAILURE TO OBSERVE A WARNING MESSAGE IS POTENTIALLY LIFE-THREATENING.**

---



### **CAUTION**

---

**A CAUTION CONTAINS INFORMATION THAT COULD PREVENT IRREVERSIBLE PRODUCT DAMAGE OR HARDWARE FAILURE. FAILURE TO OBSERVE A CAUTION COULD RESULT IN SERIOUS USER OR PATIENT INJURY.**

---



### **MANDATORY ACTION**

A Mandatory Action symbol means the instructions that follow describe a required action. Failure to observe a Mandatory Action could impact user or patient safety.



### **PROHIBITION**

A Prohibition symbol highlights a safety notice describing a prohibited action. Failure to observe a Prohibition could impact user or patient safety.

**NOTE:** A Note highlights information that helps explain a concept or procedure.

**Important:** An Important message highlights information on the proper use of the product, user expectations, error situations, and actions related to these.

## **Illustrations, Screen Displays, and Software Messages**













There may be minor language differences between software messages shown in this manual and the infuser's user interface. These differences include alternate spelling and terminology for infusers that use British English.









Illustrations and screen examples in this manual are **graphic depictions**, not exact representations of the product.













# Labeling Symbols Glossary

This section describes the symbols used in the labeling for the Plum 360 infuser.

Symbol	Description	Standards	Symbol Identifier
	Manufacturer	BS EN ISO 15223-1	Clause 5.1.1
	Authorized Representative in the European Community	BS EN ISO 15223-1	Clause 5.1.2
	Date of manufacture	BS EN ISO 15223-1	Clause 5.1.3
	Catalogue Number	BS EN ISO 15223-1	Clause 5.1.6
	Serial Number	BS EN ISO 15223-1	Clause 5.1.7
	Fragile, Handle with Care	BS EN ISO 15223-1	Clause 5.3.1
	Keep Dry	BS EN ISO 15223-1	Clause 5.3.4
	Temperature Limitation	BS EN ISO 15223-1	Clause 5.3.7
	Humidity Limitation	BS EN ISO 15223-1	Clause 5.3.8
	Atmospheric Pressure Limitation	BS EN ISO 15223-1	Clause 5.3.9
	Caution	BS EN ISO 15223-1	Clause 5.4.4
	Equipotential Terminal (Ground)	IEC 60417	Ref no. 5021
	Nurse Call Interface	IEC 60417	Ref no. 5035

Symbol	Description	Standards	Symbol Identifier
	Dangerous Voltage	IEC 60417	Ref no. 5036
	Non-ionizing electromagnetic radiation. To indicate generally elevated, potentially hazardous levels of non-ionizing radiation, or to indicate equipment or systems in the medical electrical area that include RF transmitters or that intentionally apply RF electromagnetic energy for diagnosis or treatment.	IEC 60417	Ref no. 5140
 Type CF	The administration set, which comprises the infusion liquid pathway, is an applied part for the Plum infuser. The administration set is a Type CF Applied Part complying with the higher degree of protection against electric shock. Type CF Applied Parts are those parts suitable for direct cardiac application.	IEC 60417	Ref no. 5335
	Wired Ethernet Interface Port	IEC 60417	Ref no. 5988
Class 1	Mains supply equipment using protective earth	IEC 60601-1	Clause 6.2
	Volume	IEC 60601-1	Clause 7.4.2
<b>IPX2</b>	Protection against vertically falling water drops	IEC 60601-2-24	Clause 201.11.6.5
	This Way Up	ISO 7000	Ref no. 0623
	Mandatory Action	ISO 7010	Ref no. M001
	Follow Instructions for Use	ISO 7010	Ref no. M002
	Prohibition	ISO 7010	Ref no. P001

Symbol	Description	Standards	Symbol Identifier
	Warning	ISO 7010	Ref no. W001
	Dangerous Voltage	ISO 7010	Ref no. W012
Rx Only	Federal (USA) law restricts this device to sale by or on the order of a doctor or other licensed practitioner	FDA 21 CFR 801.109	N/A
	Complies with limits for Class B digital device established by FCC Rules, Part 15	FCC 47 CFR	15.19
	CE mark	EU Medical Device Directive/Regulation	N/A
	Waste from Electrical and Electronic Equipment	EN 50419	Clause 4
	Separate Collection for Batteries with Lead	Battery Directive 2006/66/EC	Annex II
	Regulatory Compliance Mark	Australian Communications and Media Authority (ACMA) wireless regulatory authority AS/NZS 4417.1	Clause 3.2
	The 'C' and 'US' indicators adjacent to the CSA Mark signify that the product has been evaluated to the applicable CSA and ANSI/UL Standards, for use in Canada and the U.S., respectively. This 'US' indicator includes products eligible to bear the 'NRTL' indicator. NRTL (National Recognized Testing Laboratory), is a designation granted by the U.S. Occupational Safety and Health Administration (OSHA) to laboratories which have been recognized to perform certification to U.S. Standards.	CSA International	N/A

Symbol	Description	Standards	Symbol Identifier
	Complies with the Independent Communications Authority of South Africa (ICASA) Electronic Communications Act, Act No 36 of 2005	Electronic Communications Act, Act No 36 of 2005	N/A
	National Communications Commission of Taiwan (NCC) Wireless Registration	Radio Wave Regulatory	Articles 12 & 14
	Medical Device	N/A	N/A

## Definitions

Term	Definition
<b>Administration Set</b>	The cassette with flexible tubing assembly that connects a source fluid container to a patient access device for fluid administration.
<b>Air Trap</b>	A component of the cassette that allows trapping and removal of proximal air.
<b>Alarm</b>	A condition that invokes audible and/or visible alarm indicators requiring operator attention.
<b>Alert</b>	A visual signal that provides information to you or prompts further action.
<b>Alternate Units</b>	The Dose Rate units that may be selected. Alternate Units are any units other than mL/hr.
<b>Alternate Units Parameters</b>	Drug Amount, Diluent Amount, Patient Weight, Height for <b>BSA</b> (manually or calculated if applicable), and Dose Rate.
<b>Auto-Program</b>	Auto-programming refers to the ability to receive a remotely configured therapy from ICU Medical MedNet Software.

Term	Definition
<b>Backpressure</b>	The resistance to fluid flow on the <i>Distal</i> or output portion of the <i>Administration Set</i> , usually expressed as pounds per square inch (PSI).
<b>Backprime</b>	The use of fluid in <i>Line A</i> to move proximal air or fluid into a receptacle attached to <i>Line B</i> . No fluid is delivered distal to the cassette during a backprime.
<b>Biomed Mode</b>	Name for the non-delivery mode of infuser operation for hospital technicians (Biomed) who have access to technical information such as delivery parameter limits and displays default settings.
<b>Bolus</b>	A rapid infusion of a relatively large volume of fluid or dose of the drug currently being administered (same medication, concentration, and dosing unit) to enhance a therapeutic response. Also see <i>Unintended Bolus</i> on page 1-13.
<b>BSA</b>	Body Surface Area, in m <sup>2</sup> , for calculation of medication doses that require a patient's height and weight.
<b>CAIR™</b>	Trade name of ICU Medical's enhanced performance roller clamp.
<b>Cassette</b>	A component of an administration set specifically designed to work with the Plum infuser that facilitates two lines in and one line out, allowing primary and secondary I.V. delivery rates to be controlled separately.
<b>CCA</b>	Clinical Care Area. The CCA is a defined physical or virtual area in the hospital for a specific patient population that comprises rules for infuser settings and which drugs can be used along with their associated delivery limits.
<b>CDL</b>	Custom Drug Library. A drug library that is based on hospital-defined practices and customized using the ICU Medical MedNet application.
<b>CE</b>	Connectivity Engine is a component of an infuser that allows communications with the device over wired or wireless networks.

Term	Definition
<b>Channel</b>	The distal line of an administration set that connects to the patient.
<b>Cleared Settings</b>	When programmed delivery settings for an individual line or both lines are reset to their default settings.
<b>Clinical Use</b>	The clinical use attributed to a medication entry.
<b>Composite Version String</b>	The library-identifying string transmitted to the infuser by the ICU Medical MedNet application.
<b>Concentration</b>	Concentration refers to the ratio of <b>Drug Amount</b> (in mg, for example) to diluent (in mL).
<b>Concurrent Delivery</b>	Simultaneous delivery of fluids on <b>Line A</b> and <b>Line B</b> .
<b>Concurrent Mode</b>	A mode that enables the user to program Line B for Concurrent delivery.
<b>DDL</b>	Default Drug Library. A factory default non-customized drug library with a default set of infuser settings and drugs available for use and their associated concentration and dosing units. DDL has 1 to 17 pages.
<b>Delay Start</b>	A pending delivery program that will automatically start and not require operator action at the delay time programmed.
<b>Device</b>	The infuser, not including the disposable administration sets.
<b>Diluent (Volume)</b>	Volume of fluid in which a medication is diluted.
<b>Distal</b>	The portion of the <b>Administration Set</b> downstream from the <b>Cassette's</b> pumping chamber.
<b>Dose</b>	A volume of medication to be delivered on a continuous basis.
<b>Dosing Unit</b>	Unit of measure for a drug to be delivered.
<b>Drug Amount</b>	The mass or quantity of medication to be delivered before being mixed with a diluent.
<b>Duration</b>	The time period required to deliver a programmed infusion.

Term	Definition
<b>Enteral</b>	Delivery using an intestinal route.
<b>Expected Service Life</b>	The amount of time from the date of implementation that the manufacturer will provide technical service to the device. Technical service involves repairs, technical support questions and troubleshooting, and replacement parts.
<b>Filling Head Height (FHH)</b>	The height difference between the source container and the distal line output.
<b>Flush</b>	A feature that enables the clinician to flush the distal tubing volume of a piggyback therapy. The programmed Flush volume is delivered from the Line A container at the Piggyback therapy rate after the Piggyback therapy completes.
<b>Hard Limit</b>	The upper- and lower-dosing limits associated with a drug, in the drug library, that cannot be overridden by the operator.
<b>ICU Medical MedNet</b>	ICU Medical MedNet provides healthcare professionals with the capability to send, receive, and store information from infusers. The bi-directional communication between the hospital medication safety software and infusers includes infusion parameters, infuser default configurations, infuser location, history, events, trending, alarms and status.
<b>Infiltration</b>	Unintentional fluid migration into the tissues surrounding a venipuncture site.
<b>Infuser</b>	See <a href="#">Device</a> .
<b>I.V. Push</b>	The act of manually pushing on the syringe plunger to deliver the contents of medication through access at a Y-site of an administration set.
<b>Key</b>	Any of the marked locations on the front panel intended for user input via a pressing action.
<b>KVO</b>	Keep Vein Open. The Post Infusion Rate setting that provides a minimal delivery rate (1 mL/hr or the actual programmed rate when less than 1 mL/hr), intended to provide sufficient fluid flow to decrease the potential for clotting at the I.V. infusion site.

Term	Definition
<b>Line A</b>	The proximal Primary tubing attached to the A port of the cassette.
<b>Line B</b>	The proximal secondary line/syringe attached to the secondary port of the cassette.
<b>Loading Dose</b>	Allows programming of an initial infusion rate/dose for a specific volume and duration, automatically followed by a maintenance rate/dose for a specific volume and duration from the same container (for example, a fluid challenge) using the same dosing unit.
<b>Maintenance Dose</b>	A pre-programmed rate/dose for a specific volume and duration from the same container that automatically follows the completion of a <b>Loading Dose</b> .
<b>Malfunction</b>	One of a number of alarm conditions that indicate a failure of the infuser.
<b>ME Equipment</b>	Medical Electrical equipment
<b>Mode</b>	A type of secondary infusion, either Piggyback or Concurrent.
<b>Multistep</b>	A sequential program that can deliver up to 10 steps from one container at different rates, doses, <b>VTBIs</b> and durations using the same dosing unit.
<b>Non-Time-Based Dosing Unit</b>	A dosing unit that does not include a time component (for example, grams).
<b>Outgassing</b>	The release of a gas that was dissolved, trapped, frozen or absorbed in a material.
<b>Override</b>	An action by a clinician that acknowledges and confirms an alert and then proceeds with a program containing a parameter that falls outside the hospital-defined <b>Soft Limits</b> .
<b>Parenteral</b>	Delivery via other than an intestinal route, such as intravenous (I.V.) injection.
<b>Piggybackable</b>	A drug setting in a custom drug library that indicates whether a drug is allowed to be delivered in Piggyback Mode.



Term	Definition
<b>Piggyback Mode</b>	The delivery mode that suspends <b>Line A</b> delivery while <b>Line B</b> delivers. Line A resumes when Line B delivery completes.
<b>Prime</b>	The action of filling the Plum <b>Administration Set</b> , Plum <b>Cassette</b> , and all connected tubing with the fluid to be infused.
<b>Proximal</b>	Upstream (input, as <b>Line A</b> and/or <b>Line B</b> ) with respect to the <b>Cassette</b> pumping chamber portion of the Administration Set.
<b>Rate</b>	The amount of fluid pumped to the patient over a given period of time, expressed in mL/hr.
<b>Rule Set</b>	The programmed <b>Soft Limits</b> and <b>Hard Limits</b> associated with a drug entry from the <b>CCA</b> in the drug library.
<b>Service Mode</b>	A non-therapeutic mode used for configuring the infuser and changing default settings.
<b>Softkey</b>	A front panel key on the bottom portion of the display screen that is assigned specific functions within the operational context of a particular screen.
<b>Soft Limit</b>	The upper- and lower-dosing limits associated with a drug, in the drug library, that can be overridden by the operator.
<b>Standby</b>	A pending delivery program that requires operator action to begin the infusion.
<b>Tall-Man Lettering</b>	Uses uppercase letters in combination with lowercase letters to help clinicians differentiate among sound-alike or look-alike drug names.
<b>Time-Based Dosing</b>	A dosing unit that includes a time component (for example, g/min).
<b>Titration</b>	A change in <b>Rate</b> , Dose <b>Duration</b> , and/or <b>VTBI</b> in a currently running or programmed infusion.
<b>Unintended Bolus</b>	A single, unintended volume of fluid delivered. Also see <b>Bolus</b> on page 1-9.

Term	Definition
<b>Unit of Measure</b>	One of a variety of terms used to describe a drug amount, such as grams, mg, or units.
<b>VTBI</b>	Volume To Be Infused. The volume of fluid or I.V. solution (remaining) for delivery by a program or Therapy step from a Line.

## Precautions

The Plum 360 infuser has been designed and manufactured to be safe, reliable, and easy to use. This section details precautions and possible hazards.

## Warnings, Cautions, and Guidelines

For safe operation of the Plum 360 infuser, observe the Warnings, Cautions, and recommendations in the following sections.

## General Warnings and Cautions



### **WARNING**

**POSSIBLE EXPLOSION HAZARD EXISTS IF THE PLUM 360 INFUSER IS USED IN THE PRESENCE OF FLAMMABLE SUBSTANCES, INCLUDING ANESTHETICS.**

**TO AVOID THE RISK OF ELECTRIC SHOCK, THE EQUIPMENT MUST ONLY BE CONNECTED TO A SUPPLY MAINS WITH PROTECTIVE EARTH.**

**TO AVOID THE RISK OF ELECTRIC SHOCK, DO NOT OPEN THE CASE. REFER TO QUALIFIED SERVICE PERSONNEL.**

**NO MODIFICATION OF THIS EQUIPMENT IS ALLOWED.**

**NO ADDITIONAL DEVICES CAN BE CONNECTED TO THE INFUSER THAT HAVE NOT BEEN SPECIFIED AS COMPATIBLE WITH THE INFUSER BY ICU MEDICAL.**

**ARRANGE TUBING, CORDS, AND CABLES TO MINIMIZE THE RISK OF PATIENT STRANGULATION OR ENTANGLEMENT.**

---

**DO NOT OPERATE THE PLUM 360 INFUSER WITH THE CASE OPENED.**

---

**ADMINISTER ONLY ANESTHETICS/ANALGESICS APPROVED FOR EPIDURAL ADMINISTRATION (AS INDICATED OR ALLOWED BY THE DRUGS' FDA APPROVED LABELLING OR HEALTH CANADA APPROVED LABELLING). EPIDURAL ADMINISTRATION OF DRUGS OTHER THAN THOSE INDICATED FOR EPIDURAL USE COULD RESULT IN SERIOUS INJURY TO THE PATIENT.**

---

**DO NOT USE THE INFUSER IN A MRI ENVIRONMENT OR IN THE PRESENCE OF STRONG MAGNETIC FIELDS. SERIOUS INJURY OR DAMAGE TO EQUIPMENT MAY RESULT.**

---

**DO NOT USE THE INFUSER IN ANY HYPERBARIC OR OXYGEN-RICH ENVIRONMENT. SERIOUS INJURY OR DAMAGE TO EQUIPMENT MAY RESULT.**

---

**DO NOT EXPOSE THE INFUSER DIRECTLY TO X-RAYS OR ULTRASOUND; PERMANENT DAMAGE TO THE INFUSER'S ELECTRONIC CIRCUITRY MAY OCCUR.**

---

**CONSULT THE PHARMACY TO CONFIRM DRUG COMPATIBILITY, CONCENTRATION, DELIVERY RATES, AND VOLUMES ARE ALL SUITABLE FOR SECONDARY, CONCURRENT AND PIGGYBACK DELIVERY MODES.**

---



**CAUTION**

---

**EXERCISE CAUTION WHEN THE PATIENT IS AMBULATORY WHILE CONNECTED TO THE INFUSER.**

---

**Important:** Although unlikely, failure of certain robust mechanical components such as the anti-free flow mechanism or valve control springs could cause fluid delivery limited to the contents of the fluid container.

**Important:** Single fault failure of certain electronic/motor control components would result in no more than 5 mL of unexpected fluid delivery.

**Important:** Do not place the infuser in service if it fails the self-test.

## Piggyback, Concurrent, and Secondary Delivery Guidelines

Primary and secondary fluids are delivered to the patient through a common cassette and distal line. Observe the following guidelines during Piggyback, Concurrent, and Secondary deliveries.



**WARNING** \_\_\_\_\_  
**CLOSE ALL CLAMPS ON THE PRIMARY AND SECONDARY LINES, OR REMOVE THE SECONDARY CONTAINER, BEFORE OPENING THE CASSETTE DOOR TO PREVENT THE MIXTURE OF PRIMARY AND SECONDARY FLUIDS AND TO PREVENT UNRESTRICTED FLOW.**

---



**CAUTION** \_\_\_\_\_  
**IF THE PRIMARY RATE IS SET HIGHER THAN THE SECONDARY RATE, ANY DISTAL FLUID REMAINING FROM THE SECONDARY INFUSION WILL BE INFUSED AT THE HIGHER PRIMARY RATE.**

**WHEN NOT USING THE AUTO-FLUSH FEATURE, IF THE PRIMARY RATE IS SET LOWER THAN THE SECONDARY RATE, ANY DISTAL FLUID REMAINING FROM THE SECONDARY INFUSION WILL BE INFUSED AT THE LOWER PRIMARY RATE.**

**IF THE SECONDARY RATE IS SET HIGHER THAN THE PRIMARY RATE, ANY DISTAL FLUID REMAINING FROM THE PRIMARY INFUSION WILL BE INFUSED AT THE HIGHER SECONDARY RATE.**

**IF THE SECONDARY RATE IS SET LOWER THAN THE PRIMARY RATE, ANY DISTAL FLUID REMAINING FROM THE PRIMARY INFUSION WILL BE INFUSED AT THE LOWER SECONDARY RATE.**

---

### Concurrent Delivery of Critical Drugs

---



**WARNING** \_\_\_\_\_  
**ENSURE MEDICATIONS THAT ARE DELIVERED CONCURRENTLY, OR IN PIGGYBACK, ARE COMPATIBLE.**

---



**CAUTION** \_\_\_\_\_  
**AT RATES BELOW 0.4 mL/HR, PAUSES IN FLOW CONTINUITY OF MORE THAN 20 SECONDS WILL OCCUR, WHICH MAY IMPACT THE PHYSIOLOGIC RESPONSE TO DRUGS THAT HAVE A VERY SHORT HALF-LIFE.**

---

When delivering short half-life critical drugs (see **Critical Drug Examples** on page 1-18) using the Plum 360 infuser in Concurrent mode, the following delivery rate guidelines should be observed:

- If the critical drug (with half-life less than 6 minutes) is to be infused at less than 2 mL/hr, the other infusion should be no faster than 5 times the critical drug's rate. Dopamine, for example, delivered at 1.5 mL/hr should not be accompanied by an infusion programmed any faster than 7.5 mL/hr.
- If the critical drug (with half-life less than 6 minutes) is to be infused at 2 - 5 mL/hr the other infusion should be no faster than ten times the critical drug's rate. Dopamine, for example, delivered at 3.5 mL/hr should not be accompanied by an infusion programmed any faster than 35 mL/hr.
- If the critical drug (with half-life less than 6 minutes) is to be infused at 5.1 mL/hr or greater, the other infusion can be programmed at any desired rate.

**NOTE:** The total of the primary rate plus the secondary rate cannot exceed 500 mL/hr.

These guidelines apply *only* when infusing *short half-life critical drugs* in *Concurrent mode*. *Individual patient responses may vary requiring adjustment of delivery rates.*

<b>Delivery Rate Guidelines</b>	
<b>Short Half-life (less than 6 minutes) Critical Drug Infusion Rate</b>	<b>Maximum Rate of Accompanying Infusion</b>
0.5 - 1.9 mL/hr	5 Times the Critical Drug Rate
2 - 5 mL/hr	10 Times the Critical Drug Rate
5.1 or Greater	Any Desired Ratio

## Critical Drug Examples

Examples of drugs with a short half-life (approximately 6 minutes or less when given intravenously) include:

Dobutamine	Esmolol	Nitroprusside
Dopamine	Isoproterenol	Norepinephrine
Epinephrine	Lidocaine	Oxytocin
Epoprostenol	Nitroglycerin	Procainamide

For these drugs, the Concurrent flow guidelines should be followed when the infusion rate of the drug will be 5 mL/hr or less.

**NOTE:** The list of critical drugs on page 1-18 is not intended to be all-inclusive of critical drugs or drugs with a short half-life.

The clinician should become familiar with the pharmacodynamics of any critical drug before administration.

This information is presented to inform clinicians of a rare situation that could be misinterpreted if they are unfamiliar with this phenomenon.

## Guidelines When Opening the Cassette Door

**NOTE:** Opening the cassette door will stop the infusion on one or both lines.

- To prevent unrestricted flow and mixing fluids in lines A and B, close all clamps, or remove the secondary container, before opening the cassette door.
- A small amount of fluid is expelled from the set (less than or equal to 0.1 mL) each time the door is opened or closed with a set installed. If potent drugs are being used, take appropriate action to guard against over-medication of the patient.
- Keep the cassette door securely closed while the infuser is not in use to avoid cassette door damage.

## Administration Sets and Accessories Guidelines

- Plum 360 infuser operation requires single-use Plum series administration sets (PlumSets). See **Administration Sets** on page 12-1 for a representative list of Plum administration sets.
- Use only compatible PlumSets with the Plum 360 infuser. See individual set instructions for additional information.
- Administration sets should be changed at least every 96 hours. Discard after use.
- I.V. infusion sets with integral nonblood filters are not for use in the administration of blood, blood products, emulsions, suspensions, or any medications not totally soluble in the solution being administered. These medications may be administered through the lower Y-injection site, below the filter.



### **WARNING**

**WHEN INFUSING AT LOW DELIVERY RATES (5 mL/HR OR LESS) USE THICK-WALLED MICROBORE PLUMSETS. THIS WILL REDUCE THE AMOUNT OF THE UNINTENDED FLUID BOLUS THAT MAY BE DELIVERED WHEN A DISTAL OCCLUSION IS RELEASED.**

- Microbore PlumSets are not recommended at flow rates above 100 mL/hr.



### **WARNING**

**USE OF MICROBORE SETS AT RATES GREATER THAN 100 ML/HR MAY INCREASE THE LIKELIHOOD OF DISTAL OCCLUSIONS RESULTING IN DELAY OF THERAPY, AND REDUCE SYSTEM ACCURACY AS STATED IN THE *Delivery Accuracy* SECTION STARTING ON PAGE 11-10.**

- When infusing at delivery rates of 0.1 to 999 mL/hr, macrobore PlumSets may be used.
- When attaching a syringe to the primary port (Line A), use standard clinical practices to ensure the syringe is secure in order to reduce the chances of creating a proximal occlusion.
- Syringes must be between 3 mL (minimum) to 60 mL (maximum). Syringes larger than 10 mL may be directly attached to the

secondary port of the cassette. Small volume syringes, i.e., 3-10mL, require a vented syringe adapter to ensure delivery accuracy and reduce proximal occlusion alarms. For syringe sets on Line A, use a vented syringe adapter with all syringes from 3 mL to 60 mL.

- Before disconnecting a syringe from the cassette, pull up the plunger slightly to avoid spilling the fluid.
- Before disconnecting a rigid container from the cassette, close the upper slide clamp or clamp proximal tubing, open the cassette door, and then remove and invert the cassette (ports down) to avoid spilling the fluid.

## Precautions to Avoid Unintended Bolus

In addition to the following procedure, refer to [\*Maximum Unintended Bolus Volume Released After Distal Occlusion is Resolved on page 11-9.\*](#)

Use the following procedure to avoid the administration of an unintended bolus following a distal occlusion:

1. If the administration set does not have a clamp distal to the cassette, disconnect the tubing from the patient while eliminating the distal occlusion.

If the administration set has a clamp on the distal line, ensure that the clamp is closed (even if the closed clamp caused the distal occlusion alarm).

2. Close all clamps on the primary and secondary lines.
3. Open the cassette door and remove the cassette.
4. Gently pull out the flow regulator on the cassette to dissipate the pressure for a brief moment, and then push in on the flow regulator to close it.
5. Eliminate the source of occlusion, unless it was caused by a closed distal clamp. (The distal clamp must remain closed until Step 8.)
6. If the distal line was removed, reattach it to the patient access device.
7. Reinsert the cassette and close the cassette door.



## 8. Open all clamps and resume infusion.

For other conditions that may cause an unintended bolus to be administered, see [Guidelines When Opening the Cassette Door on page 1-18](#) and [Administration Sets and Accessories Guidelines on page 1-19](#).

## Guidelines to Avoid Air in the Patient Line

- Air bubbles may form distal to the cassette as the result of normal outgassing of dissolved air in the fluid in one or more of the following cases:
  - Chilled solution is in use.
  - Certain fluids known to routinely outgas are in use.
  - The infuser is mounted significantly above the patient. Minimize this differential (head height) when outgassing is a concern.
  - The infuser is infusing at very low rates between 0.1 and 5 mL/hr.

In these cases, an air-eliminating filter may be used when clinically appropriate.

- Repeated opening and closing of the door may defeat the proximal air-in-line alarm and may cause a distal air-in-line alarm, requiring repriming.
- When using a syringe adapter, retract the plunger to draw approximately 1 mL of fluid into the syringe to clear air from the adapter filter.

## Guidelines During Backpriming

- Backpriming is not recommended for reconstituting secondary containers containing dry powders.
- To avoid pressurization when backpriming into a syringe, confirm that there is sufficient empty space to accept the backprimed fluid before beginning a backprime.

- During a backprime, fluid is pumped from the container on Line A to a line or syringe attached to the secondary port (Line B) at a rate of approximately 1 mL every 5 seconds.
- To accept the backprimed air and/or fluid, a line with a container or a syringe needs to be attached to the secondary port.

## Battery Guidelines



Use AC (mains) power whenever possible. Connect to AC (mains) power during storage to ensure a fully charged battery for emergencies.

- Do not operate the Plum 360 infuser on patients when the battery is removed. Use of a properly maintained and charged battery helps to ensure proper operation.
- The battery may not be fully charged upon receipt. Connect the infuser to AC (mains) power for at least eight hours.
- If the quality of the earth grounding source is in doubt, use battery power.
- If the low-battery alarm sounds, connect the infuser to AC (mains) power immediately.

## Guidelines During Cleaning

- The infuser must be cleaned prior to first use on a patient.
- To avoid mechanical or electronic damage, do not immerse the Plum 360 infuser in any fluids or cleaning solutions.
- Do not spray cleaning solutions toward any opening in the instrument.
- Certain cleaning and sanitizing solutions may slowly degrade components made from some plastic materials. Using abrasive cleaners or cleaning solutions not recommended by ICU Medical may result in product damage. Do not use compounds containing combinations of isopropyl alcohol and dimethyl benzyl ammonium chloride.

- Never use sharp objects such as fingernails, paper clips, or needles to clean any part of the infuser.
- Do not sterilize by heat, steam, ethylene oxide (ETO), or radiation.
- To avoid infuser damage, cleaning solutions should only be used as directed. The disinfecting properties of cleaning solutions vary; consult the manufacturer for specific information.

For more information, see [Cleaning the Infuser](#) on page 10-1 and the *Plum 360 Infuser Technical Service Manual*.

## Artifacts

Nonhazardous, low-level electrical potentials are commonly observed when fluids are administered using infusion devices. These potentials are well within accepted safety standards, but may create artifacts on voltage-sensing equipment such as ECG, EMG, and EEG machines. These artifacts vary at a rate that is associated with the infusion rate. If the monitoring machine is not operating correctly or has loose or defective connections to its sensing electrodes, these artifacts may be accentuated so as to simulate actual physiological signals.

To determine if the abnormality in the monitoring equipment is caused by the infusion device instead of some other source in the environment, set the infusion device so that it is temporarily not delivering fluid. Disappearance of the abnormality indicates that it was probably caused by the electronic noise generated by the infusion device. Proper setup and maintenance of the monitoring equipment should eliminate the artifact. Refer to the appropriate monitoring equipment system documentation for setup and maintenance instructions.

The Plum 360 infuser is designed to operate normally in the presence of most encountered electromagnetic interference (EMI) conditions. The Plum 360 has been tested for electromagnetic immunity compliance in accordance with professional healthcare environment immunity requirements of IEC/EN 60601-1-2 Edition 4 standard. This device has also been tested for extended EMI immunity in the event of extreme levels of interference encountered next to an electrosurgical generator at a separate distance of  $\frac{1}{2}$  meter and found

to present no observable hazards in the presence of bipolar electrosurgical generator up to 80W of RF power and unipolar electrosurgical generator up to 300W of RF power at 490kHz +/- 5kHz and associated harmonics.

This equipment has been tested and found to comply with the EMC limits for its classification of medical device. Those limits are designed to provide reasonable protection against harmful interference in a typical medical installation. The equipment generates, uses and can radiate radio frequency energy and, if not installed and used in accordance with the instructions, may cause harmful interference to other devices in the vicinity. However, there is no guarantee that interference will not occur in a particular installation. If this equipment does cause harmful interference with other devices, which can be determined by turning the equipment off and on, the user is encouraged to try to correct the interference by one or more of the following measures:

- Reorient or relocate the receiving device
- Increase the separation between the equipment
- Connect the equipment into an outlet on a circuit different from that to which the other device(s) is connected
- Consult the manufacturer or field service technician for help



**CAUTION**

---

**PORTABLE AND MOBILE RF COMMUNICATIONS EQUIPMENT, SUCH AS CELLULAR TELEPHONES, 2-WAY RADIOS, BLUETOOTH™ DEVICES, MICROWAVE OVENS, IN CLOSE PROXIMITY TO THIS DEVICE MAY AFFECT WIRELESS AND WIRED COMMUNICATIONS WITH THE INFUSER AND/OR THE OPERATION OF THE INFUSER.**

---

Special cautions need to be exercised regarding EMC. These include:

- Use of a shielded Ethernet cable (CAT5 STP or better) for plugging into the RJ45 Ethernet connector. Using an unshielded Ethernet cable may result in increased emissions or decreased immunity performance.

- Maintaining a minimum separation distance of 2 ½ ft (77 cm) between the infuser system and portable/mobile RF communications equipment.

## Interconnecting of Medical Equipment

Accessory equipment connected to the analog and digital interfaces must be certified according to the respective IEC Standards (for example, IEC 60950 for data processing equipment and IEC 60601-1 for Medical Equipment). Any person who connects additional equipment to the signal input or output part configures a medical system, and is therefore responsible for ensuring that the system complies with the requirements of Standard IEC/EN 60601-1.

## Electromagnetic Compatibility

The Plum 360 infuser has been tested to the requirements of the standards in the following table:

Standard	Pump Labeling Inventory Code		
	05/06	09/10	13/14
IEC/EN 60601-1-2:2007 Edition 3	X	X	X
IEC 60601-1-2:2014 Edition 4 EN 60601-1-2:2015 Edition 4			X
IEC 60601-1:2012 EN 60601-1:2013	X	X	X
IEC 60601-2-24:2012 EN 60601-2-24:1998	X	X	X

The Plum 360 device has been evaluated and tested for safety and essential performance under the scope and requirements of IEC/EN 60601-1-2 Edition 4 (as defined in the table above) under the professional healthcare environment immunity category for following electromagnetic tests and found to be compliant:

- Radiated and Conducted Emissions (CISPR 11 Group 1 Class B)

- Harmonic Current Emissions (IEC 61000-3-2)
- Voltage Fluctuation and Flicker (IEC 61000-3-3)
- ESD Immunity (IEC 61000-4-2)
- Radiated RF Field Immunity (IEC 61000-4-3)
- Proximity Fields from wireless transmitters (IEC 61000-4-3)
- Electrical Fast Transients (IEC 61000-4-4)
- Surge Immunity (IEC 61000-4-5)
- Conducted Immunity (IEC 61000-4-6)
- Conducted Immunity to ISM band (IEC 61000-4-6)
- Magnetic Field Immunity (IEC 61000-4-8)
- Voltage Dips and Interruptions (IEC 61000-4-11)

The infuser is suitable for use in clinical professional healthcare environments in accordance with the provisions of IEC 60601-1-2:2014 Edition 4/EN 60601-1-2:2015 Edition 4 Medical Electrical equipment standard for basic safety and essential performance for electromagnetic disturbances. The infuser is suitable for use in all establishments, excluding domestic establishments. The infuser is Group 1<sup>a</sup> Class B<sup>b</sup> Medical Electrical equipment for electromagnetic disturbance emissions purposes.



**WARNING**

**THIS EQUIPMENT IS INTENDED FOR USE BY HEALTHCARE PROFESSIONALS ONLY. THIS EQUIPMENT/SYSTEM MAY CAUSE RADIO FREQUENCY INTERFERENCE OR MAY DISRUPT THE OPERATION OF NEARBY EQUIPMENT, DEVICES, OR SYSTEMS USING RF ELECTRICAL ENERGY FOR THEIR OPERATION. THE USER MIGHT NEED TO TAKE MITIGATION MEASURES, SUCH AS RELOCATING OR RE-ORIENTING THE PLUM 360 EQUIPMENT OR SHIELDING THE LOCATION.**

- 
- a. Group 1 ME equipment includes:
    - equipment that generates or uses RF energy only for its internal functioning, or
    - equipment intended to deliver energy to the patient in a form other than RF electromagnetic (such as infusion pumps).
  - b. Class B equipment is suitable for use in all establishments including domestic surroundings.

The essential performance of a Plum 360 device consists of:

- Delivery accuracy
- Free flow avoidance under single-fault condition
- Alarm generations and conditions

If the essential performance of the infuser is affected due to an electromagnetic disturbance event or if you suspect external RF sources or other equipment are influencing device operation, stop usage of the device and contact the biomedical engineering department for additional guidelines concerning electromagnetic immunity. Contact the biomedical engineering department for additional information in the *Plum 360 Infuser Technical Service Manual* concerning operating devices near RF sources or sources of electromagnetic disturbance.

Refer to the *Plum 360 Infuser Technical Service Manual* for further details of the EMC testing procedures and compliance levels. There is a shared responsibility between manufacturers, customers and users to ensure that Medical Equipment and Systems are designed and operated as intended. Medical electrical equipment needs special cautions regarding electromagnetic compatibility and needs to be installed and used according to the electromagnetic compatibility information provided in this manual.

Always manage the electromagnetic environment.

The guidance included in this manual provides information needed to:

- Determine the device's suitability for use in the intended environment.
- Manage the electromagnetic environment to permit the device to perform as intended without disturbing other equipment.

Separate the device from all other electronic equipment. If the device must be used near other electrical equipment, monitor the equipment to ensure there is no electromagnetic interference.



**WARNING**

**DEVICES SHOULD NOT BE USED ADJACENT TO OR STACKED WITH OTHER EQUIPMENT. IF THE DEVICE MUST BE USED ADJACENT TO OR STACKED WITH OTHER EQUIPMENT, MONITOR THE DEVICES TO VERIFY NORMAL OPERATION.**



**WARNING**

**USE ONLY COMPONENTS AND ACCESSORIES SPECIFICALLY LABELED FOR USE WITH THE PLUM 360 INFUSER TO HELP ENSURE THE DEVICE OPERATES AS INTENDED. USE OF UNAUTHORIZED ACCESSORIES, CABLES, TRANSDUCERS AND EQUIPMENT MAY HAVE A RISK OF AFFECTING THE EMISSIONS AND IMMUNITY COMPLIANCE REQUIREMENTS OF THE PLUM 360 INFUSER.**

## FCC Information



### US FCC (Federal Communications Commission) Statement (United States Only)

The device has been tested and found to comply with the limits for a Class B digital device, pursuant to Part 15C, 15E of the FCC rules. These limits are designed to provide reasonable protection against harmful interference.

Operation is subject to the following two conditions: (1) This device may not cause interference, and (2) This device must accept any interference, including that may cause undesired operation of these devices.

### FCC Interference Statement (United States Only)

This equipment has been tested and found to comply with the limits for a Class B digital device, pursuant to Part 15 of the FCC rules. These limits are designed to provide reasonable protection against harmful interference in a residential installation. This equipment generates, uses, and can radiate radio frequency energy and, if not installed and used in accordance with the instructions, may cause harmful interference to radio communications. However, there is no guarantee that interference will not occur in a particular installation.

If this equipment does cause harmful interference to radio or television reception, which can be determined by turning the



equipment off and on, the user is encouraged to try to correct the interference by one or more of the following measures:

- Reorient or relocate the receiving antenna
- Increase the separation between the equipment and receiver
- Connect the equipment to an outlet on a circuit different from that to which the receiver is connected
- Consult the dealer or an experienced radio/television technician for help

This device and its antenna(s) must not be co-located or operated in conjunction with any other antenna or transmitter.

## **Department of the Minister of Innovation, Science, and Economic Development (Canada Only)**

The Class B digital apparatus complies with Canadian ICES-003.

## **Radio Frequency Exposure Statement**

The Wireless LAN radio device in the Connectivity Engine peripheral assembly with this infusion device has been evaluated and found compliant to the requirements of the following Radio Frequency exposure standards.

## **FCC Rules, Part 15/Industry Canada**

This device complies with Part 15 of FCC Rules and Industry Canada license-exempt RSS standard(s). Operation is subject to the following two conditions:

- (1) This device may not cause harmful interference, and
- (2) This device must accept any interference, including interference that may cause undesired operation of this device.

This equipment complies with FCC/IC radiation exposure limits set forth for an uncontrolled environment and meets the FCC radio

frequency (RF) Exposure Guidelines in Supplement C to OET65 and RSS-102 of the IC radio frequency (RF) Exposure rules.

Under Industry Canada regulations, this radio transmitter may only operate using an antenna of a type and maximum (or lesser) gain approved for the transmitter by Industry Canada. To reduce potential radio interference to other users, the antenna type and its gain should be so chosen that the equivalent isotropically radiated power (e.i.r.p.) is not more than that necessary for successful communication.

This radio transmitter (identify the device by certification number, or model number if Category II) has been approved by Industry Canada to operate with the antenna types listed below with the maximum permissible gain and required antenna impedance for each antenna type indicated. Antenna types not included in this list, having a gain greater than the maximum gain indicated for that type, are strictly prohibited for use with this device.

For product available in the USA/Canada market, only channels 1-11 can be operated. Selection of other channels is not possible. If this device is to be operated in the 5.15~5.25 GHz frequency range, it is restricted to indoor environments only.

Antenna:	Proprietary
Antenna Gain Information:	Embedded Antenna: 4.2dBi (2.4 GHz), 5.1dBi (5 GHz)
Frequency Tolerance:	±20ppm

## Radio Equipment Directive

Hereby, ICU Medical, Inc. declares that the radio equipment type Wireless Local Area Network is in compliance with Directive 2014/53/EU.

The full text of the EU declaration of conformity is available at the following internet address:

<http://www.icumed.com/about-us/qualityregulatory-certificates>

## RoHS

ICU Medical, hereby declares that this Plum Infusion Pump is in compliance with Directive 2011/65/EU on the restriction of the use of certain hazardous substances in electrical and electronic equipment (RoHS).

## Taiwan NCC Warning Statement

According to “Administrative Regulations on Low Power Radio Waves Radiated Devices”

Without permission granted by the NCC, any company, enterprise, or user is not allowed to change frequency, enhance transmitting power or alter original characteristic as well as performance to an approved low power radiofrequency devices. The low power radio-frequency devices shall not influence aircraft security and interfere legal communications; If found, the user shall cease operating immediately until no interference is achieved. The said legal communications means radio communications is operated in compliance with the Telecommunications Act.

The low power radio-frequency devices must be susceptible with the interference from legal communications or ISM radio wave radiated devices. Device will avoid affecting the operation of the radar system nearby. High-gain directivity antenna will only use for the stationary point-to-point system.

經型式認證合格之低功率射頻電機，非經許可，公司、商號或使用者均不得擅自變更頻率、加大功率或變更原設計之特性及功能。低功率射頻電機之使用不得影響飛航安全及干擾合法通信；經發現有干擾現象時，應立即停用，並改善至無干擾時方得繼續使用。前項合法通信，指依電信法規定作業之無線電通信。低功率射頻電機須忍受合法通信或工業、科學及醫療用電波輻射性電機設備之干擾。避免影響附近雷達系統之操作。高增益指向性天線只得應用於固定式點對點系統

# Suspected Cybersecurity Event or Threat

The section contains information on the recommended procedure upon detecting a suspected cybersecurity event or threat.

1. Contact hospital and/or follow hospital guidelines to report the suspected cybersecurity event or threat.

Attempts to exploit a remote vulnerability on an infusion device would require penetration of several layers of network security enforced by the hospital, including firewalls. These measures serve as the primary defense against tampering with a medical device.

2. **Contact ICU Medical** to report the suspected cybersecurity event or threat.

## Section 2

# Equipment Description

For a technical description of the Plum 360 infuser, see the *Plum 360 Infuser Technical Service Manual*.

The Plum 360 infuser includes the infuser (pumping module) and attached Connectivity Engine peripheral module (CE module), and this System Operating Manual. The CE module provides wired Ethernet and wireless 802.11 a/b/g/n local area networking capabilities. This allows the infuser to connect to the facility's network and communicate with the optional ICU Medical MedNet networked application software to download software and drug libraries, and to enable auto-programming features. Optional accessories are also available.

Each infusion requires a disposable, single-use Plum administration set to provide the fluid path between the fluid container and the patient access device. Each administration set includes a proprietary cassette that works with the pumping mechanism on the infuser to provide accurate fluid delivery and air management.

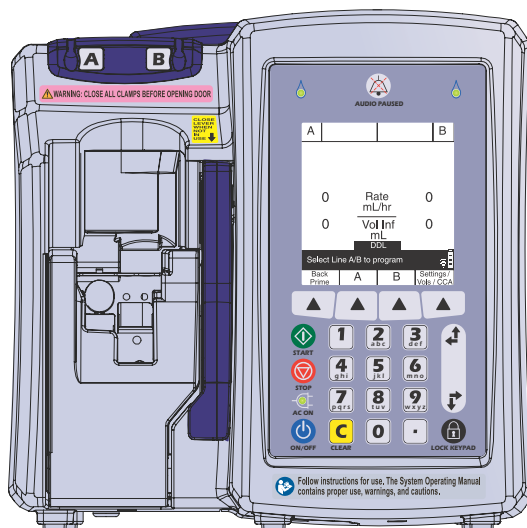

See [Section 12](#) for a representative list of Plum administration sets and optional accessories.

The following sections describe the Plum 360 infuser hardware and Plum administration sets.

## Keypad and Display

This manual covers Plum 360 infusers with an alphanumeric keypad and Plum 360 infusers with a numeric keypad.

The screen examples used in this manual are representative of an infuser with an alphanumeric keypad.

### Alphanumeric Keypad

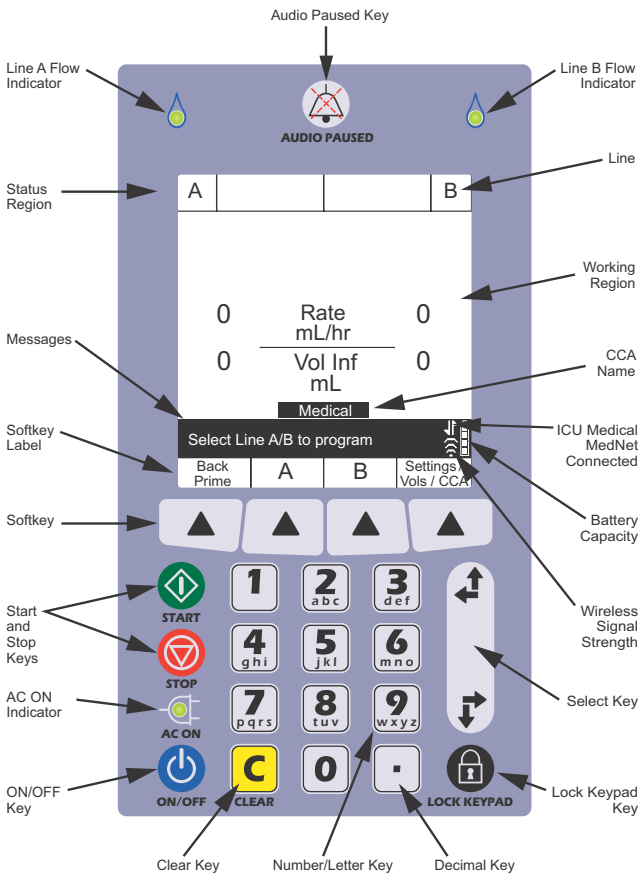

# Numeric Keypad

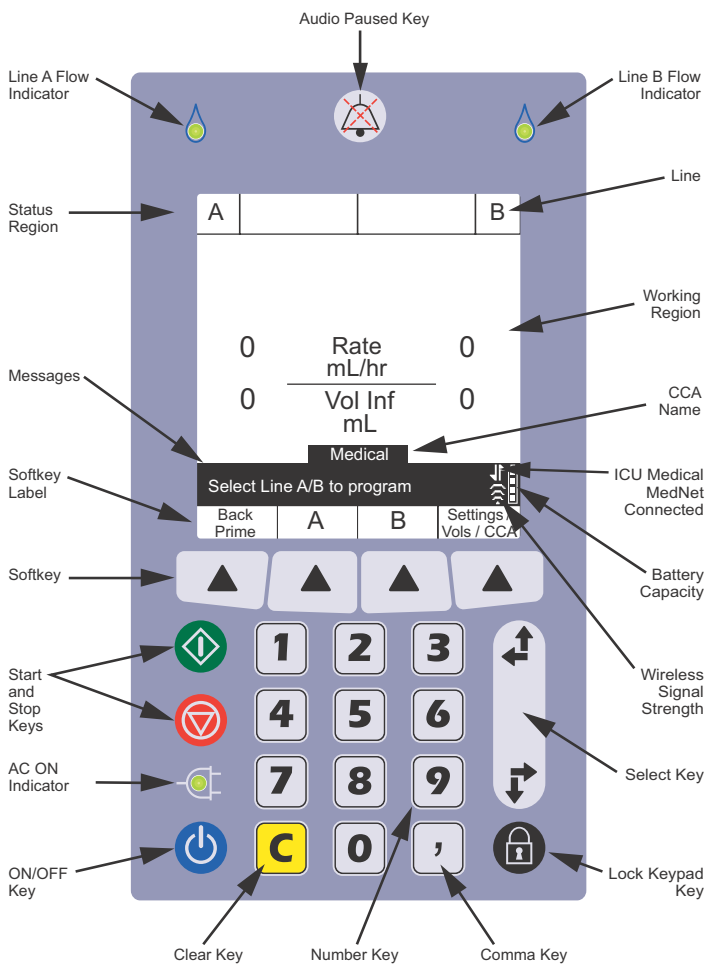

# Operating Keys



**[ON/OFF]** - Infuser power on and off. See [Turning Power On](#) and [Turning Power Off](#) for more information.



**[START]** - Is the first key to press to start a delivery. For safety reasons, every delivery must be confirmed by checking the programming and then pressing an additional softkey, in response to a prompt.



**[STOP]** - Stops delivery. If two lines are pumping when you press [STOP], you must press one of the following softkeys: [▲\[Stop A\]](#), [▲\[Stop B\]](#), or [▲\[Stop All\]](#) in response to a prompt to specify which line(s) to stop (*see page 2-6 for more information about softkeys*).



**[SELECT]** - Moves the cursor between fields on the display. The top pair of arrows moves the cursor up or to the left.

The bottom pair of arrows moves the cursor down or to the right.



**[LOCK KEYPAD]** - Pressing this key, followed by entering a lock passcode, disables all keys on the keypad except [STOP] until a valid unlock passcode is entered. See [Locking and Unlocking the Keypad](#) for more information.





**[AUDIO PAUSED]** - Has two functions, temporarily silencing all audio output for any active alarms for two minutes or temporarily silencing keypad input sound feedback for two minutes if there are no active alarms. See [Programming a Callback Alarm](#) and [Silencing the Keypad](#) for more information.



**[C]** - Clears all values in the currently-highlighted field.

[C] also clears the dashes (-- -- --) that are displayed when an entry is invalid or a drug delivery parameter is beyond the pre-programmed hard limits.

**NOTE:** [C] will NOT clear an entire program.



**Alphanumeric Keypad - [DECIMAL KEY]** - Adds the decimal point needed when entering numbers other than whole numbers (1.2 mL, for example).

**NOTE:** On the infuser display, any digits after the decimal point will be  $\frac{3}{4}$  of the height of the whole number digits.



**Numeric Keypad - [COMMA KEY]** - Adds the comma needed when entering numbers other than whole numbers (1,2 ml, for example).

**NOTE:** On the infuser display, any digits after the comma will be  $\frac{3}{4}$  of the height of the whole number digits.



### Alphanumeric Keypad -

**Number keys** - Have two functions, entering numbers in any highlighted field and navigating through the drug library.

See [Using the Keypad to Enter Program Information](#) and [Using the Keypad to Search the Drug List](#) for more information.

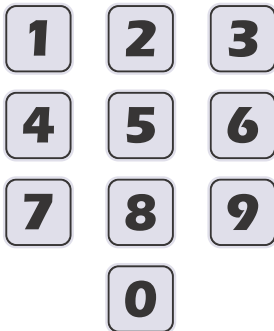

### Numeric Keypad -

**Number keys** - To enter numbers in any highlighted field.

See [Using the Keypad to Enter Program Information](#) for more information.

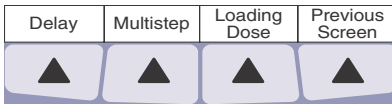

**Softkeys** - Offer functions that are appropriate for the screen currently being displayed.

The current function for each softkey appears on the display; you press the triangular key below it to choose the function.

In this manual, softkeys are represented by a triangle and the name in brackets; ▲[Delay], for example.

## Indicators



**Flow Indicator** - Green LED that blinks while a delivery is in progress, lights steadily when a delivery is in Standby or is Delayed, Stopped, or Paused, and is off when a delivery is not programmed for the line.

There are two flow indicators above the display. The one on the left is for Line A, the one on the right is for Line B.



**AC ON Indicator** - Green LED that lights steadily when the infuser is plugged into AC (mains) power. During this time, the battery charges continuously when a battery is installed.

If the infuser is unplugged, the AC ON Indicator light goes off within seconds, indicating that the infuser is operating on battery power.

**NOTE:** If the device is plugged into AC (mains) power with a battery installed, and the AC ON Indicator is not illuminated, contact technical support.

## Display Symbols



**Caution** - appears on the display to inform the clinician to use CAUTION because the specified drug has been programmed without rule sets (soft or hard limits), and may have been programmed outside of specified safety limits for that specific drug.



**Upper Soft Limit Override** - appears next to the drug name when the dosage of the drug being infused is higher than the upper soft limit set for the drug in the Custom Drug Library (for systems with ICU Medical MedNet software only).



**Lower Soft Limit Override** - appears next to the drug name when the dosage of the drug being infused is less than the lower soft limit set for the drug in the Custom Drug Library (for systems with ICU Medical MedNet software only).



**Wireless Signal Strength** - appears when the infuser is communicating with the network using a wireless connection.

The number of bars indicate the strength of the wireless connection. The following figure shows the signal strength from highest on the left to lowest on the right.



If the signal strength is low, try relocating the infuser closer to the access point.



**Ethernet** - appears when the infuser is communicating with the network over a wired (Ethernet) connection.



**ICU Medical MedNet Connected** - appears when the infuser is communicating with ICU Medical MedNet software over either a wireless or Ethernet connection.



**Battery Capacity** - shows the battery charge level when a battery is installed in the infuser, or indicates that a battery is not installed.

The following figure shows all possible appearances for this symbol. From left to right, the symbols represent 100%, 75%, 50%, and 25% charge levels, a fully-depleted battery, and a battery not installed.

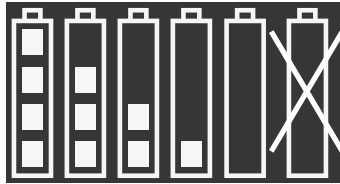

**Alarm** - appears when an alarm is currently active.

The following figure shows the two states for this symbol. The appearance changes to the symbol on the right when all audio output is temporarily silenced by pressing the [AUDIO PAUSED] key.



**Alarm Priority** - appears before each alarm message, indicating the priority. This symbol has three possible states:

!!! - High priority alarm

!! - Medium priority alarm

! - Low priority alarm

The infuser also sounds the appropriate high, medium, or low auditory alarm signal.



**Lock** - appears when the keypad is locked (see [Locking and Unlocking the Keypad](#) on page 3-13).

## CE Module

Connection of the Plum 360 infuser to an IT network could result in previously unidentified risks to patients, operators, or third parties. The organization that makes those connections must identify and control those risks.

The wireless CE (Connectivity Engine) Module attached to the back of the infuser provides both wired Ethernet and wireless 802.11 networking capabilities for connection to ICU Medical MedNet software on your facility's network (see [ICU Medical MedNet Safety Software](#) on page 12-16).

In addition to its communications features, the CE Module includes these infuser controls:

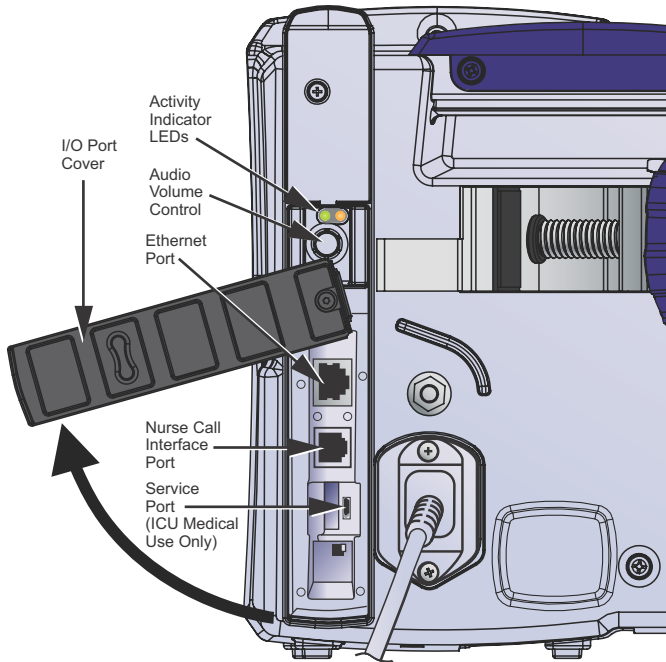



**Activity Indicator LEDs** – These LEDs show CE Module activity.

CE Module Activity	LED Color	Indication
Powering up and performing self-check tests.	Green	On
	Yellow	On
Ready for operation.	Green	Blinking
	Yellow	Off
Communicating via Ethernet or Wi-Fi.	Green	Blinking
	Yellow	Blinking
Module is shut down* or there is system failure.	Green	Off
	Yellow	Off

\* For information about CE shutdown, see the *Plum 360 Infuser Technical Service Manual*.



**Audio Volume Control** – adjusts the sound level of the audible alarm. Rotate the knob clockwise to increase the volume. Rotate the knob counterclockwise to decrease the volume.



**Nurse Call Interface Connector**– connects to the facility's Nurse Call System to provide remote notification for all infuser alarms (see [Attaching a Nurse Call Interface Cable](#)).



**Ethernet port** – accepts a shielded Ethernet cable to connect to a local area network.

## Pole Clamp, Potential Equalization Terminal, and Power Cord

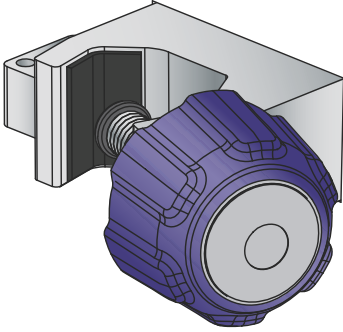

**Pole Clamp** - adjusts to fit round I.V. poles from 0.5 - 1.5 inches (1.2 cm to 3.8 cm) in diameter. See [Mounting the Infuser on an I.V. Pole](#) on page 3-3 for more information. When the pole clamp is tight enough, a ratcheting sound indicates that the clamp is being over-tightened.

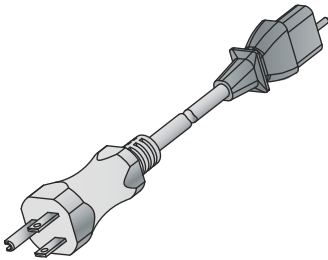

**Power Cord** - plugs into AC (mains) power to provide power, charge the battery, and ground the infuser enclosure and chassis. The power cord connection to the infuser is protected by an enclosure to prevent accidental disconnection. The power cord can be replaced if damaged (see the *Plum 360 Infuser Technical Service Manual*).



**INSPECT CORD BEFORE USE.**  
When plugging in, use straight forward motion.



**INSPECT CORD AFTER USE.**  
When unplugging, grasp plug and pull straight out. Do not pull cable to unplug.

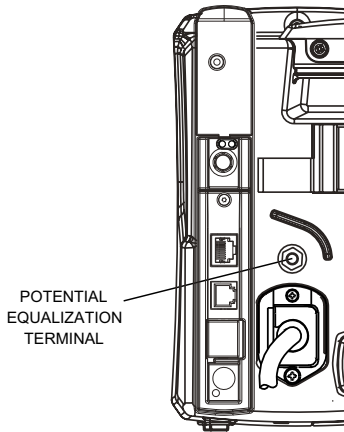

**Potential Equalization Terminal -**

is used to ensure that the infuser is at the same electric potential (voltage) as the other devices in the treatment location. Ideally the electrical potential is at zero volts, so that no current can inadvertently flow from one device to another through a patient.

When the infuser's power cord is connected to an AC (mains) outlet, the grounding wire of the power cord forces the infuser enclosure and chassis to be at zero volts. If the infuser power cord is not connected to the mains outlet, a separate grounding cord should be connected from the Potential Equalization Terminal to a grounding terminal in the treatment location.

# Plum Administration Sets

Plum administration sets are available for a wide variety of uses, including intravenous, blood, enteral, and epidural deliveries. Intravenous, epidural, and blood sets are supplied sterile. Some sets have additional features such as burettes, filters, or special tubing.

See [Administration Sets](#) on page 12-1 for a representative list of Plum administration sets.

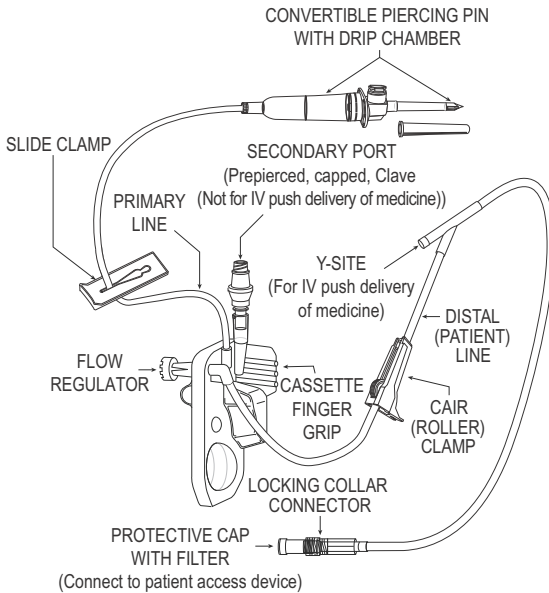

The following sections describe the most common features. See [Section 4](#) for instructions on how to prepare and use Plum administration sets. See set packaging for specific instructions.

## The Plum Cassette

Each PlumSet includes a proprietary cassette that works with the infuser's pumping mechanism to provide fluid delivery, air management, and occlusion detection.

The following figure shows the parts of the cassette.

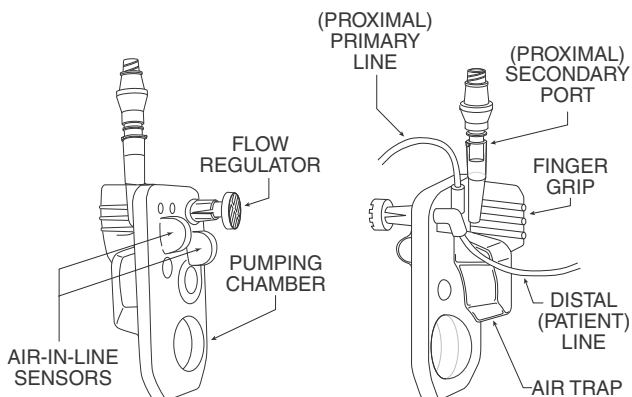

The air trap allows 1 mL of air before the infuser sounds a cassette alarm. To remove air bubbles from the air trap, perform **Backpriming**.

Most cassettes also include a secondary port for attaching a line or syringe for Piggyback or Concurrent fluid delivery. The secondary port has one of these connectors:

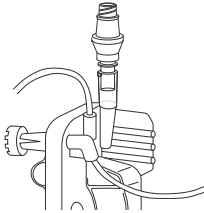

**Clave** secondary ports are compatible with sets or syringes that employ male luer adaptors for connection. Clave secondary ports are incompatible with needles. The Clave needle-less design provides a mechanically- and microbiologically-closed fluid path.

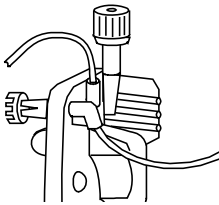

**Capped** secondary ports are also compatible with secondary sets or syringes that employ male luer adaptors for connection. Capped ports are incompatible with needles.

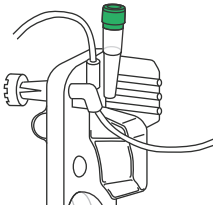

**Prepierced** secondary ports accept a locking blunt cannula attached to a secondary line or syringe.

The cassette also has these features:

- A **finger grip** to assist placing the cassette in the correct position, to guide and load it into the door tracks of the cassette door.
- A **pumping chamber** that works with the pumping mechanism on the infuser to pump fluid to the patient.
- An **air trap** that collects air bubbles from the I.V. proximal A and B lines. Air trap capacity is 2 mL of air that can be removed by backpriming (see **Backpriming** on page 4-21).
- **Air-in-line sensor bulbs** that work with the proximal and distal air-in-line detectors in the infuser to check for air bubbles that may be entering or leaving the cassette.
- A **flow regulator** that can be used to manually control flow during priming or when using gravity flow to deliver fluid. When you insert the cassette into the infuser and close the cassette door, a mechanism opens the flow regulator to allow the infuser to control fluid flow. When you open the cassette door, the same mechanism closes the flow regulator to prevent unrestricted flow from the distal line.

## Other Administration Set Features

Most Plum administration sets have some combination of the following features. For complete information about all the features of a particular administration set, refer to the label on the administration set packaging.

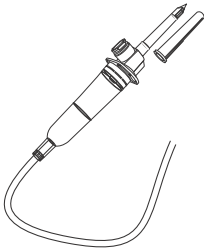

The **convertible piercing pin** spikes the seal on the fluid container and secures the administration set tubing to the container.

The piercing pin has a built-in filter vent that allows use with flexible or rigid fluid containers, and an integrated drip chamber with score mark for monitoring fluid flow.

If using a rigid fluid container (glass bottle, for example), open the filter vent cover above the drip chamber. If using a flexible plastic container, make sure this vent cover is closed.

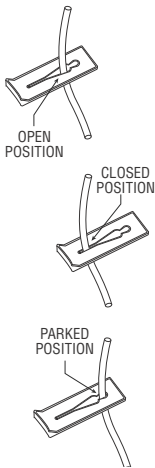

**Slide clamps** can be placed anywhere on the tubing. The shape of the cutout provides three clamp positions:

- **Open** position, in the middle of the cutout, allows fluid to flow and also allows the clamp to slide freely on the tubing.
- **Closed** position, at the narrow end of the cutout, clamps the line, preventing fluid flow. The closed clamp stays in a fixed position on the tubing.
- **Parked** position, at the wide end of the cutout, also allows fluid to flow, but keeps the clamp in a fixed position on the tubing to prevent movement.

**Roller Clamps** allow controlled fluid flow.

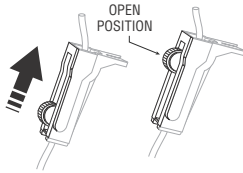

- To gradually increase fluid flow, slide the roller towards the fully **Open** position.

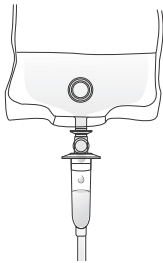

- Observe the fluid drops in the drip chamber.

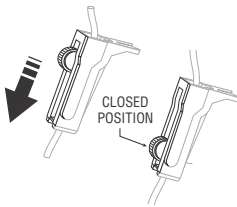

- To gradually decrease and then stop fluid flow, slide the roller towards the fully **Closed** position.

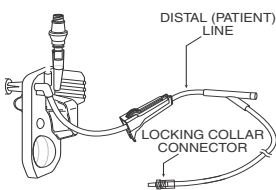

The **distal line** (patient line) runs from the cassette to the patient.

The **connector** that attaches the distal line to the patient access device has a locking collar that prevents accidental disconnection.

**NOTE:** The cap on the connector has a filter that allows the set to be primed while the cap is on as long as the cap stays dry. Cap is a sterile fluid path barrier when in place.

---

---

# Notes

---

---



---

## Section 3

# Basic Operations

---

The Plum 360 infuser does not require any special implementation. Before placing the infuser into service for the first time, the only preparation needed is to have a biomedical technician customize the default settings according to the facility's needs, clean the infuser, and then fully charge the battery. See the ***Plum 360 Infuser Technical Service Manual*** for more information.

If using ICU Medical MedNet safety software, the infuser must also be connected to the facility's network to download infuser configuration, Clinical Care Area (CCA), and Custom Drug Library (CDL) information before being placed into service.

Once these preparations are complete, follow these basic steps to deliver fluids to the patient:

1. Mount the infuser on an I.V. pole (see ***Mounting the Infuser on an I.V. Pole*** on page 3-3), or place the infuser on a stable surface.



Do not place the infuser on an unstable surface.



**WARNING** 

---

**CONNECT THE AC (MAINS) CORD TO A PROPERLY GROUNDED RECEPTACLE.** 

---

2. Connect the power cord to an AC (mains) power receptacle and confirm that the green AC ON indicator lights.



Ensure that access to the mains plug is not blocked while using the infuser so that the plug can be disconnected from the mains power receptacle in the event of an emergency.



**INSPECT CORD BEFORE USE.** When plugging in, use straight forward motion.



**INSPECT CORD AFTER USE.** When unplugging, grasp plug and pull straight out. Do not pull cable to unplug.

3. (Optional) Attach a Nurse Call Cable between the Nurse Call Interface Port on the back of the infuser and your facility's Nurse Call system (see [Attaching a Nurse Call Interface Cable](#) on page 3-4).
4. Prime and install a Plum administration set (see [Priming a Primary Administration Set](#) on page 4-2). Confirm that the cassette door is closed before attaching an administration set to the patient access device.
5. Turn the infuser on and allow it to successfully complete the Self Test (see [Turning Power On](#) on page 3-10).
6. Attach the administration set to the patient access device.
7. Program the delivery and start the infusion ([Programming](#) on page 5-1 and [Delivery Options](#) on page 8-1).

# Mounting the Infuser on an I.V. Pole



## CAUTION

**FOR STABILITY AND TO RESIST TIPPING, MOUNT INFUSER TO THE I.V. POLE PER THE PROVIDED INSTRUCTIONS. VERIFY STABILITY BEFORE USE.**

The Plum infuser pole clamp is designed to be mounted on an I.V. pole with a diameter from 0.5 - 1.5 inches (1.2 cm to 3.8 cm). To do this:

1. Make sure the pole is assembled correctly, rests on a stable surface, and is placed where infuser operations will not be affected by other equipment.



## CAUTION

**IF THE PLUM INFUSER IS BEING USED NEXT TO OTHER ELECTRICAL/ELECTRONIC EQUIPMENT, OBSERVE THE FUNCTIONING OF THE INFUSER TO ENSURE THAT IT IS NOT BEING AFFECTED BY ELECTROMAGNETIC INTERFERENCE FROM OTHER DEVICES BEING USED IN THE VICINITY OF THE INFUSER.**

2. Turn the pole clamp knob counterclockwise until the gap between the pole clamp and the pole clamp screw is wide enough to fit the I.V. pole.
3. Grasp the infuser by the handle and position the clamp around the I.V. pole.
4. Rest the pole against the infuser's pole support. Refer to [Section 12, Accessories](#), for proper mounting height.
5. With your other hand, turn the pole clamp knob clockwise to secure the infuser to the pole.

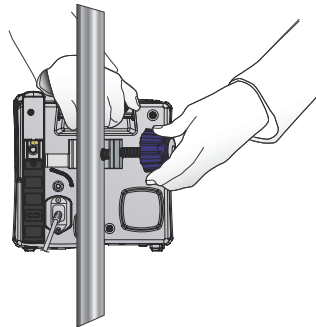

**NOTE:** The Plum 360 infuser pole clamp has a ratchet

mechanism that produces an audible click when properly tightened. When the pole clamp is tight enough, a ratcheting sound indicates that the clamp is being over-tightened.



**CAUTION**

---

**MAKE SURE THE POLE CLAMP IS TIGHTENED PROPERLY AND THE INFUSER IS SECURELY ATTACHED TO THE POLE, TO PREVENT PERSONAL INJURY OR DAMAGE TO THE INFUSER.**

---

6. Push down and pull up on the infuser to confirm that it is tightly clamped to the I.V. pole, without vertical or rotational slippage.

If you detect slippage, loosen the pole clamp screw, realign the pole clamp, tighten the pole clamp screw, and then check again.

## Mounting Multiple Infusers to an I.V. Pole

If there is a need to mount multiple infusers on an I.V. pole, refer to the [I.V. Pole](#) section on page 12-11 or the [Multiple Device Adapter](#) section on page 12-9.

## Attaching a Nurse Call Interface Cable

The Plum 360 infuser can connect to your facility's Nurse Call system through the Plum Nurse Call Interface cable (see [Accessories](#) on page 12-7).

### To connect the infuser to a Nurse Call system:

1. Attach the rectangular connector on the Nurse Call interface cable to the Nurse Call interface connector that is built into the CE unit on the back of the infuser.
2. Attach the other end of the cable to the Nurse Call System port at the patient's bedside.

## Opening the Cassette Door



### WARNING

**CLOSE ALL CLAMPS ON THE PRIMARY AND SECONDARY LINES, OR REMOVE THE SECONDARY CONTAINER, BEFORE OPENING THE CASSETTE DOOR TO PREVENT THE MIXTURE OF PRIMARY AND SECONDARY FLUIDS AND TO PREVENT UNRESTRICTED FLOW.**

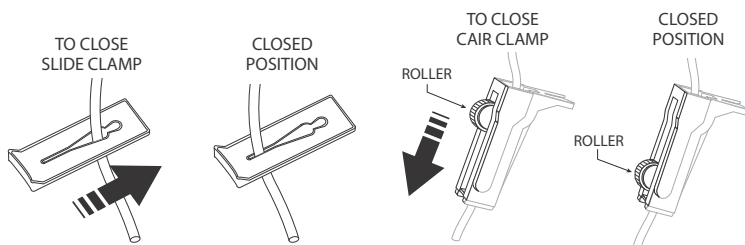

### CAUTION

**A SMALL AMOUNT OF FLUID IS EXPELLED FROM THE SET (LESS THAN OR EQUAL TO 0.1 mL) EACH TIME THE CASSETTE DOOR IS OPENED OR CLOSED WITH A SET INSTALLED. IF POTENT DRUGS ARE BEING USED, TAKE APPROPRIATE ACTION TO GUARD AGAINST OVERMEDICATION OF THE PATIENT.**

Infuser components located behind the cassette door interact with the cassette to control fluid flow, preventing primary and secondary fluids from mixing, and allowing fluid to reach the patient only when the infuser is pumping. The fluid regulator closes to prevent fluid flow to a patient.

When you open the cassette door, infuser components are no longer in contact with the cassette. **Always close all clamps before you open the cassette door** so that fluid does not flow into drip chambers.

#### To open the cassette door:

1. Make sure that all slide clamp and lower CAIR (roller) clamps are closed before opening the cassette door.

2. Lift the cassette door lever as shown in the following illustration.

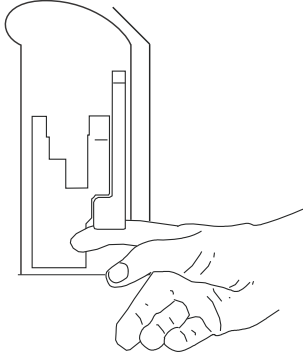

# Opening the Cassette Door Completely

The cassette door can be opened flat if needed, for example, to retrieve a dropped cap, remove a stuck cassette, or wipe a spill.



## **WARNING**

**CLOSE ALL CLAMPS ON THE PRIMARY AND SECONDARY LINES, OR REMOVE THE SECONDARY CONTAINER, BEFORE OPENING THE CASSETTE DOOR TO PREVENT THE MIXTURE OF PRIMARY AND SECONDARY FLUIDS AND TO PREVENT UNRESTRICTED FLOW.**

### To open the cassette door completely:

1. Close all slide clamp and lower CAIR (roller) clamps before opening the cassette door.

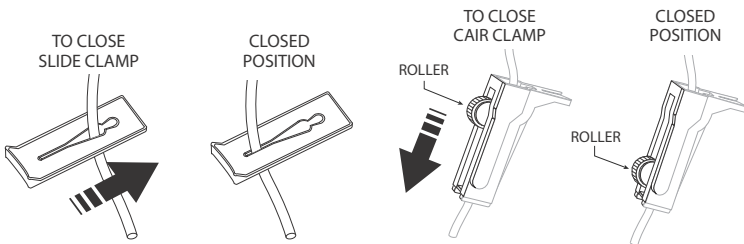

2. Lift the cassette door lever to open the cassette door.

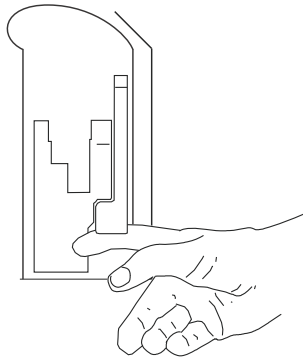

3. Press the yellow door release tab on the lower part of the door lever to disengage the cassette door from the door latch, and then gently press the cassette door down until it opens completely.

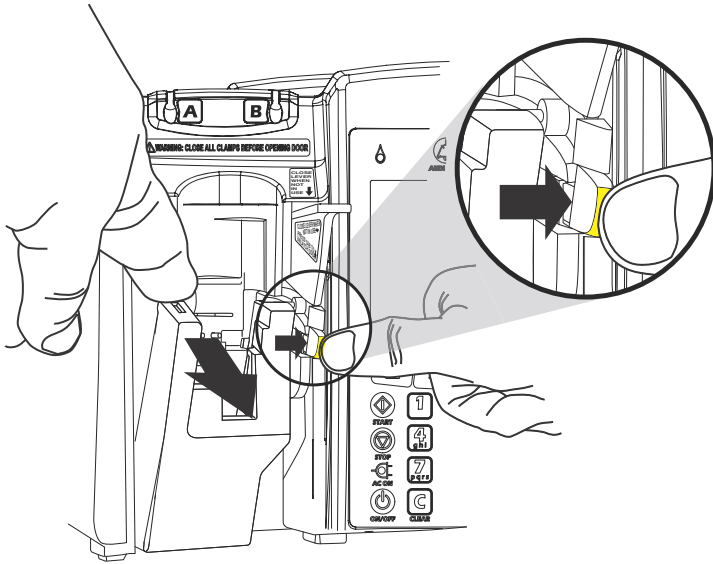

**NOTE:** The precision pumping mechanism located behind the cassette door includes pins and sensors that can be damaged by rough handling.



## Closing the Cassette Door

Keep the cassette door closed while not in use to avoid damage to the cassette door.

To close the cassette door, press down on the cassette door lever.

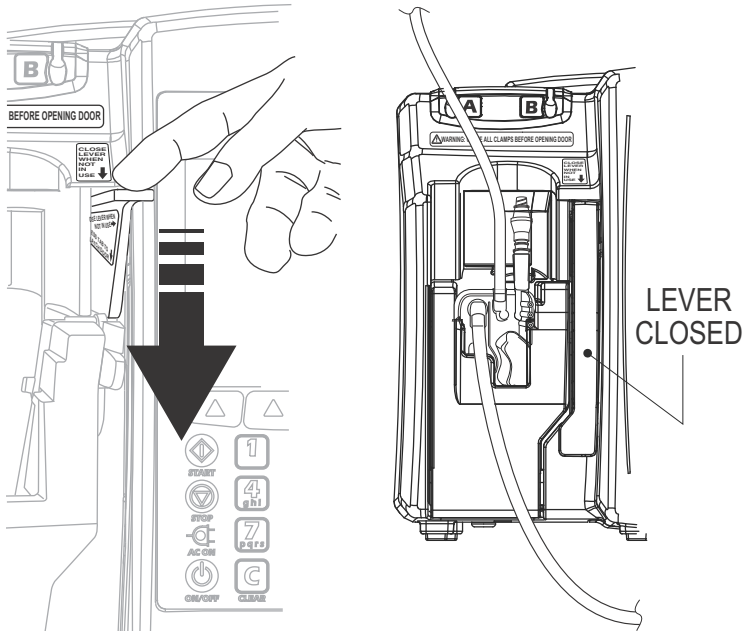

If the infuser is turned on when you close the cassette door, the cassette test begins automatically.

## Turning Power On

Each time you turn the power on, the infuser performs a System Self Test to check the operation of critical systems and alarms, then prompts for a cassette, if one is not already installed. The infuser then performs a cassette test that checks for air bubbles and verifies the integrity of the cassette's pumping components.



### **CAUTION**

**DO NOT USE THE INFUSER ON A PATIENT IF THE BATTERY IS NOT INSTALLED.**

**Important:** Do not use the infuser if the Self Test fails.

**NOTE:** A small amount of fluid may be expelled from the set (less than or equal to 0.2 mL) when the infuser is powered on. If potent drugs are being used, take appropriate action to guard against over-medication of the patient.

Cassette test failure can be caused by improper cassette priming. In that case, perform backpriming to resolve the problem. If the test still fails, replace the administration set with a properly primed set. If the failure persists, replace the infuser.

### **To turn power on:**

1. Make sure the power cord is plugged into AC (mains) power and that the infuser is mounted securely on an I.V. pole or located on a stable surface.



Ensure that access to the mains plug is not blocked while using the infuser so that the plug can be disconnected from the mains power receptacle in the event of an emergency.



**INSPECT CORD BEFORE USE.** When plugging in, use straight forward motion.



**INSPECT CORD AFTER USE.** When unplugging, grasp plug and pull straight out. Do not pull cable to unplug.

2. Press [ON/OFF] until you hear a beep and the Line A and Line B flow indicators (drip symbols) briefly blink.

The infuser checks for a cassette and then begins the System Self Test, followed by the cassette test.

**NOTE:** For software version 15.11 and later, while the self test is in progress, the infuser displays the drug library version and the infuser and CE software versions.

**NOTE:** The CE version will only display if the CE has connected to the infuser at least once.

- If you see the prompt “Insert PLUM Set, Close Lever,” insert a primed Plum cassette into the infuser to continue.
- With software version 15.11 and later, you can view and clear volume infused totals while the Insert PLUM Set prompt displays by pressing ▲[Volumes Infused]. See *Viewing and Clearing the Volumes Infused* on page 3-27.
- If you see the prompt “New Patient?” the infuser has a stored program from the last delivery. To clear the programming, press ▲[Yes]; to keep it, press ▲[No].

**NOTE:** If the cassette test fails while the New Patient? prompt is displayed, press ▲[Yes] or ▲[No], as appropriate, and then hold down ▲[Back Prime] to clear air from the cassette. See *Backpriming* on page 4-21 for more information.

**NOTE:** For software version 15.11 and later, if a Drug Library issue is identified during the System Self Test, you will be advised to return the infuser to the hospital biomedical staff.

## Turning Power Off

**NOTE:** Always turn the infuser off when not in use, to reduce the consumption of electrical energy.

You can only turn power off if the status is STOPPED or blank for both lines.

### To turn power off:

1. Stop all active deliveries (see [Stopping and Restarting a Delivery](#) on page 3-22).
2. Press [ON/OFF] until you hear a beep.

**NOTE:** If the Plum 360 infuser has been turned off for longer than five hours, all delivery settings are cleared and programming options are restored to their default selections for next use.

**NOTE:** If a drug library is available for installation at power down, based on the configuration either the user will be prompted to accept it or it will install automatically.

## Viewing the Display

When operating the infuser, position yourself at a distance of no more than 39 inches (1 M) from the display.

Make sure you are directly in front of the display, or at an angle of no more than 20 degrees off this position.

## Using the Keypad and Controls

The alphanumeric keypad on the Plum 360 infuser has two functions, entering information to program a delivery and searching through the drug library.

## Using the Keypad to Enter Program Information

When entering numbers in a Program screen (to program a delivery rate or VTBI, for example), highlight the field and press the number keys as needed.

- Use [Decimal] when entering numbers other than whole numbers (1.2 mL, for example).
- Use [SELECT] to move the cursor between programming fields.
  - Press the top pair of arrows to move up or to the left.
  - Press the bottom pair of arrows to move down or to the right.
- Press [C] to clear all values in the currently-highlighted field or to clear the dashes (-- -- --) that are displayed when an entry is invalid or a drug delivery parameter is beyond the pre-programmed hard limits.

**NOTE:** [C] will NOT clear an entire program.

## Silencing the Keypad

To silence key press feedback sounds when there are no active alarms, press [AUDIO PAUSED]. A message will display while key press feedback is silenced.

Keypad sounds resume automatically after 2 minutes.

When the infuser enters an alarm state, silencing is deactivated and keypad sounds automatically resume.

## Locking and Unlocking the Keypad

A passcode is used to both lock and unlock the keypad. Please **contact ICU Medical** or the hospital Biomedical staff for the code. The same passcode is used to both lock and unlock the keypad.

The keypad can be locked to prevent unauthorized use. The keypad lock disables all keys on the keypad except [STOP] until a valid passcode is entered.

For safety reasons, [STOP] will stop an active delivery, even when the keypad is locked. ▲[Stop All], ▲[Stop A], ▲[Stop B], and ▲[Cancel] are all functional.

Pressing [STOP] or opening the cassette door during an infusion while the keypad is locked activates an alarm that cannot be silenced until a valid passcode is entered and the keypad is unlocked.

If an incorrect passcode is entered, the infuser displays an error message.

- The number of unsuccessful attempts to unlock the keypad entered is displayed in the passcode dialog box, so you can monitor the infuser for attempts at unauthorized access.
- Each attempt is also recorded in the infuser log. Logs can be retrieved by the Biomedical staff. See the *Plum 360 Infuser Technical Service Manual* for more information.

### To lock the keypad (Method #1):

1. Press the [LOCK KEYPAD] hard key.
2. The Passcode data entry screen appears on the display.
3. Enter the passcode using the numeric keypad.
4. Press the ▲[Enter] soft key.

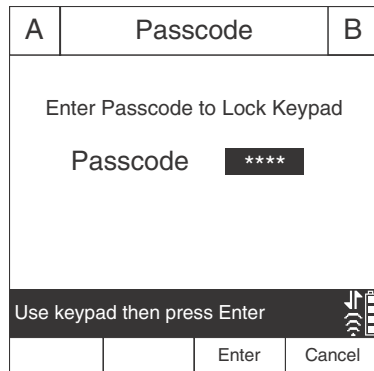

When the keypad is locked, the lock symbol  appears in the bottom right corner of the delivery screen.

**To lock the keypad (Method #2):**

1. At the main delivery screen, press the ▲[Settings/Vols/CCA] soft key.
2. The Settings/Vols/CCA screen appears on the display.

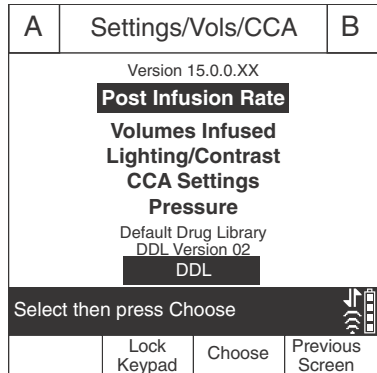

3. Press the ▲[Lock Keypad] soft key.

The Passcode data entry screen appears on the display.

4. Enter the passcode using the numeric keypad.
5. Press the ▲[Enter] soft key.

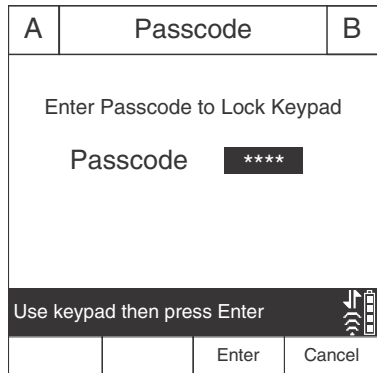

When the keypad is locked, the lock symbol appears in the bottom right corner of the delivery screen.

### To unlock the keypad:

1. Press any key on the keypad to display the Passcode data entry screen.
2. Enter the passcode using the numeric keypad.
3. Press the ▲[Enter] soft key.

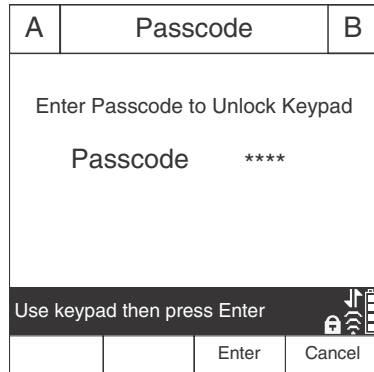

**NOTE:** During infusion, pressing [STOP], or opening the cassette door, activates an alarm that cannot be silenced until the keypad is unlocked.

### Using the Keypad to Search the Drug List

You can quickly locate a drug in the drug list by using the keypad to spell up to the first three letters of the drug name.

The following figure shows how each number key matches up to a letter. Since each key represents more than one letter, more than one keypress may be required to enter the letter.





**To search the drug list and select a drug:**

1. Display the drug list.
  - For systems with ICU Medical MedNet software, the custom drug list appears after you select a CCA and Line A or Line B.
  - For systems without ICU Medical MedNet software, select Line A or Line B and press ▲[Drug List] to display the DDL.
2. Press the key that represents the first letter of the drug name.  
If the letter you need is not in the first position on the key, repeat the keypress quickly to enter the letter you need.  
  
For example, press the 5 key once to enter J, or quickly press 5 twice to enter K, or quickly press 5 three times to enter L.
  - To enter a number, quickly press the key an additional time. For example, to enter 5, quickly press the 5 key four times.
  - As you spell the name, the infuser sorts the drug list and displays only the matching drugs.
  - To sort further, wait for the screen to display “Press 0-9 to refine sort”, and then use the keypad to enter the second letter. Repeat, if needed, to enter the third letter of the drug name.

**NOTE:** To restart your search at any time, press [C].
3. Use ▲[Page Down], ▲[Page Up], and [SELECT] as needed to select the drug from the sorted list, and then press ▲[Choose].

# Working with Alarms

Alarms on the Plum 360 infuser have two components, a message that appears on the display and an audible signal. The infuser has an intelligent alarm system that handles more than one alarm at a time. There are different indicators for high, medium, and low priority alarms, as shown in the following table.

Alarm Priority	Display Indicator	Audio Indicator
High	!!! + message	A series of tones in a 3-2-3-2 cadence, repeated every 2 seconds
Medium	!! + message	Double tone repeated every 2 seconds
Low	! + message	Double tone repeated every 10 seconds

If a Nurse Call Interface cable is connected to the facility's Nurse Call system, the infuser also sends a signal to that system each time an alarm is activated (see [Attaching a Nurse Call Interface Cable on page 3-4](#)).

See [Alarms and Troubleshooting on page 9-1](#) for descriptions of alarms, their priorities, and how to resolve them.

## Test the Alarm System

To test the alarm system before using on a patient:

1. Load a non-primed cassette in the infuser and power the infuser on if it is not already on.
2. Verify the Cassette Test Failure alarm activates and the audible alarm sounds.

3. Verify the alarm volume is appropriate for the patient environment.
4. Adjust the volume using the Volume Control knob on the back of the infuser, if necessary.
5. Press the [AUDIO PAUSED] key, and verify that the alarm audio is paused.

## Responding to an Alarm

1. If the keypad is locked out, enter the unlock code on the keypad.
2. Press [AUDIO PAUSED] to silence the audible part of an alarm for 2 minutes. The alarm symbol on the display changes:



The display also flashes and shows the alarm message until the alarm condition is resolved.

**NOTE:** The Low Battery alarm is silenced for 15 minutes.

**NOTE:** For software versions 15.11 and later, the Replace Battery alarm is silenced for 15 minutes.

**NOTE:** Alarm sounds resume after the silence period expires, but can be paused again if resolving the alarm condition takes more time.

3. Check the display for the alarm message.
4. Correct the alarm condition (see [Alarms and Troubleshooting](#) on page 9-1).
5. Press [START] to resume infusion. If more than one line is programmed, press ▲[Start A], ▲[Start B], or ▲[Start All] as needed.

**NOTE:** Each alarm puts an entry in the infuser logs. If troubleshooting does not correct the problem, contact the

Biomedical department, who can check the logs and further isolate the problem.

A malfunction alarm alerts you to turn off the infuser and restart it. If the alarm continues, replace the infuser.

## Adjusting the Audio Alarm Volume



### **WARNING**

---

**CHECK THAT THE ALARM VOLUME LEVEL IS APPROPRIATE FOR THE CURRENT PATIENT AND BACKGROUND NOISE LEVEL BEFORE USE ON THE PATIENT.**

---

The alarm volume control knob is located on the back of the infuser (see [CE Module](#) on page 2-10).

- To **increase** the volume, turn the knob clockwise.
- To **decrease** the volume, turn the knob counterclockwise.

## Programming a Callback Alarm

You can program a Callback Alarm to alert you to each interim step of a Loading Dose or Multistep delivery, or to notify you that a Piggyback or Bolus delivery has ended. See [Delivery Options](#) on page 8-1 and [Standby](#) on page 7-1 for more information.

A Callback Alarm is a medium priority alarm that must be acknowledged by the clinician. To turn off a Callback Alarm, press [AUDIO PAUSED].

If a Nurse Call Interface cable is connected to the facility's Nurse Call system, the infuser also sends an alarm signal to that system.

## Restarting the Delivery Automatically After a Distal Occlusion Alarm

- When the infuser detects a distal occlusion, delivery stops immediately and the infuser issues an alarm. The Plum 360 infuser can restart the delivery automatically if the distal occlusion clears

within 60 seconds. This gives time to resolve the occlusion without the need to restart the delivery manually by pressing the [START] key. During the 60 seconds, the infuser monitors the pressure, the delivery screen displays the status PAUSED, and the infuser issues a **medium priority** alarm. As soon as the pressure drops below the Distal Occlusion Alarm Limit, the alarm clears and delivery restarts immediately.

- If the occlusion is not resolved within 60 seconds, or the maximum number of restarts is exceeded, the delivery status changes to STOPPED. The alarm priority changes from **medium** to **high**. The change in the audible alarm cadence alerts you that you must intervene to resolve the alarm (see [Working with Alarms](#) on page 3-18 for descriptions of the audible alarms).
- When two lines are delivering, if either line exceeds the maximum number of restarts, the priority changes to high and the alarm must be resolved manually by pressing the [START] key.

If ICU Medical MedNet software is installed, each CCA can be configured to allow up to 10 restarts per infusion. For software version 15.11 and later, the allowed restarts are managed within a rolling 15-minute window. Without ICU Medical MedNet software, the number of restarts can be configured by the Biomedical staff for the default CCA (DDL). To view the maximum number of restarts for the current CCA, see [Viewing CCA and Infuser Settings](#) on page 3-31.

## Stopping and Restarting a Delivery

The following procedure describes how to stop and restart an active delivery. Active deliveries include not only those that have the status PUMPING, but also those that are in STANDBY, DELAYED, or PENDING.

Where two lines are active, pressing [STOP] does not stop any lines. You must choose to stop only one line or stop all or cancel the attempt.

### To stop a delivery:

1. Press [STOP].
  - If only one line is active, pumping stops immediately.
  - If both lines are active, the infuser prompts you to choose which line to stop.
2. Press ▲[Stop A] or ▲[Stop B] to stop the individual line or press ▲[Stop All] to stop both at once.

To cancel the request and not stop any lines, press ▲[Cancel].

**NOTE:** When two lines are active when you press [STOP], the infuser will alarm after 15 seconds if you don't press a softkey to choose the line(s) to stop. Pressing the [STOP] hardkey does not stop infusion.

Opening the cassette door will stop the infusion on one or both lines.

If you are stopping the infusion entirely, see [Discontinuing Fluid Administration](#) on page 4-28 for instructions on removing the administration set from the patient. See [Discontinuing Electronic Flow Control and Setting Gravity Flow](#) on page 4-25 for instructions on removing the administration set from the infuser but continuing fluid administration.



**WARNING** 

---

**CLOSE ALL CLAMPS BEFORE OPENING THE CASSETTE DOOR!** 

---

**To restart a delivery:**

1. Press [START]. If only one line was pumping when delivery was stopped, pumping resumes immediately.
  - If the line was in DELAYED, the Delay countdown resumes where it left off when the line was stopped.
  - If the line was in STANDBY, pumping resumes when you press [START]. To return the line to Standby, press ▲[Standby].
2. If both lines are stopped, the infuser prompts you to choose which line to start. Press ▲[Start A] or ▲[Start B] to start the corresponding line, or press ▲[Start All] to start both lines at once. If either line is in DELAYED or STANDBY, the infuser responds as described in Step 1.

To cancel the request to resume pumping, press ▲[Cancel].

If no soft key is pressed within 15 seconds, an alarm will sound.

## Clearing a Line

When you clear a line, all the programming is cleared for that line. The Volume Infused reading for that line is not cleared. The Volume Infused reading for the other line and the Total Volume reading are not affected.

Each time you close the cassette door or turn the infuser on, the infuser prompts “New Patient?” to give you the option to clear all settings on both lines. This is a safety feature to ensure that a patient does not get a stored delivery that was programmed for a different patient. If you press ▲[Yes], all programming and Volumes Infused data are cleared and settings are returned to their defaults.

**To clear a line:**

1. If the line you want to clear is pumping, press [STOP].
2. Record the volume infused for the line, if needed (see [Viewing and Clearing the Volumes Infused](#) on page 3-27).
3. Press ▲[A] or ▲[B] to choose the line to clear.

4. In response to the prompt, press ▲[Yes].
5. To cancel clearing a line and resume pumping, select ▲[No], [START], and then ▲[Yes].

## Setting the Post Infusion Rate

After the programmed VTBI is delivered, the infuser issues a VTBI Complete alarm and begins delivering a Post Infusion Rate. The default Post Infusion Rate setting is KVO, but the default setting can be changed to Rate in ICU Medical MedNet custom drug libraries as follows:

- For software versions 15.02 through 15.11, through a Master Infuser setting
- For software versions 15.20 and later:
  - For No Drug Selected and Label Only medications, through a CCA setting
  - For all other medications, through a rule set setting for the medication

On infusers without ICU Medical MedNet software (using the default drug library), the Post Infusion Rate default setting can be changed by a biomedical technician.

You can change the default setting to one of the following:

- **KVO** - the infuser continues to deliver fluid at a Keep Vein Open (KVO) rate of 1 mL/hr. If the delivery rate of the infusion that just completed was less than 1 mL/hr, the KVO rate will continue at the same delivery rate (for example, if the delivery rate was 0.5 mL/hr, the KVO rate will be 0.5 mL/hr).
- **Rate** - the infuser continues to deliver fluid at the programmed rate, maintaining the therapeutic rate until the VTBI Complete alarm can be resolved.

For a Concurrent delivery, the Post Infusion Rate is set for both lines. As each line completes its VTBI delivery, that line begins infusing automatically at the Post Infusion Rate.



For a Piggyback delivery, the Post Infusion Rate does not apply on Line B. The infuser switches to Line A automatically when the Piggyback Delivery is complete.

When Line A is no longer in a Pending state (STANDBY, DELAYED, CLEAR, or STOPPED) and Piggyback delivery is complete, a “VTBI Completed Line B! Add more VTBI OR Clear B” alarm is received.

For software versions 15.20 and later, the Post Infusion Rate setting can only be changed for Line A if the line is programmed.

For software versions 15.20 and later, the Post Infusion Rate setting can only be changed for Line B if the line is programmed with a concurrent delivery.

**To set the Post Infusion Rate:**

1. If the infuser is running, stop the infusion.
2. On the delivery screen, press ▲[Settings/Vols/CCA]. The Settings/Vols/CCA screen appears, with Post Infusion Rate highlighted.

**NOTE:** For software versions 15.20 and later, the Post Infusion Rate screen can only be accessed if there is a confirmed program on Line A or a confirmed concurrent program on Line B.

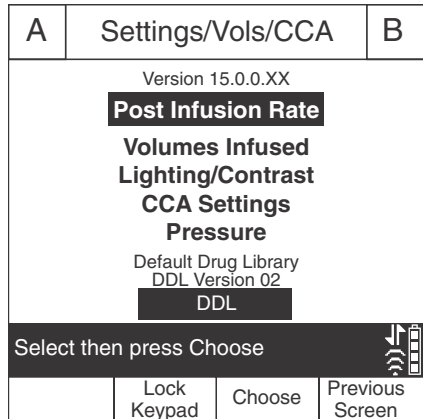

3. Press ▲[Choose].  
The Post Infusion Rate screen appears, with the current setting highlighted.
4. For software versions 15.11 and earlier, press ▲[KVO/Rate] to toggle the setting between KVO and Rate.

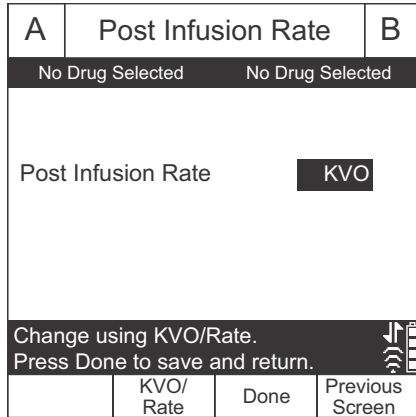

For software versions 15.20 and later, press ▲[Change A] or ▲[Change B] (as available) to toggle the setting for that line between KVO and Rate.

5. Press ▲[Done] to save your changes and return to the Settings/Vols/CCA screen, and then press ▲[Previous Screen] to return to the delivery screen.

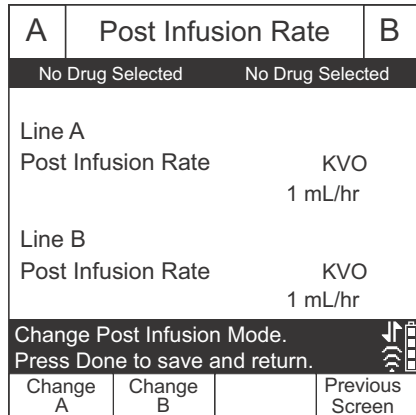

## Post Infusion Rate (Loading Dose Delivery and Multistep Delivery)

During a Loading Dose delivery or a Multistep Delivery, you can stop the Post Infusion Rate and make changes (perform titration) to the VTBI. For more information, see [Adding VTBI to Loading Dose or Multistep Program After VTBI Complete Alarm Activates on page 8-9](#).

## Viewing and Clearing the Volumes Infused

The infuser records the volume infused during each delivery and keeps separate records for Line A and Line B, and a cumulative total for both lines. The recorded volume infused is retained for 5 hours after the infuser is turned off.

The following procedure describes how to view the volume infused records and clear them when necessary.

**NOTE:** All programming, including the volumes infused, is cleared when you turn the infuser off, and then turn it on again, then answer “Yes” to the “New Patient?” prompt, or when you select a new CCA.

**To view and clear the volumes infused before a cassette is inserted (available with software version 15.11 and later):**

1. Power on the infuser without a cassette inserted.
2. When the “Insert PLUM Set Close Lever” prompt displays, press ▲[Volumes Infused].  
The screen displays the volumes infused on Line A, Line B, and the Total Volume infused on both lines since the last time the values were cleared.

Setup	
Heparin	locane
Insert PLUM Set Close Lever	
Volume Infused Line A	4 mL
Volume Infused Line B	5 mL
Total Volume Infused	9 mL
Clear A, Clear B or Clear Total?	
Clear A	Clear B
Clear Total	

3. To continue without clearing any values, insert a set and close the lever.
4. To clear the Volumes Infused data:
  - Press ▲[Clear A] to clear the Line A total only.
  - Press ▲[Clear B] to clear the Line B total only.
  - Press ▲[Clear Total] to clear all values, including the Total Volume.
  - To continue, insert a set and close the lever.

For software versions 15.02 and 15.20 and later, clearing the volume infused totals on this screen also clears the associated volume infused total(s) on the delivery screen.

For software versions 15.10 and 15.11, clearing the volume infused totals on this screen does NOT clear the associated volume infused total(s) on the delivery screen.

**To view and clear the volumes infused after a cassette has been inserted:**

1. On the main delivery screen (of a Plum 360 infuser with ICU Medical MedNet software), press ▲[Settings/Vols/CCA] to display the Settings/Vols/CCA screen shown on page 3-25.
2. Use [SELECT] to highlight Volumes Infused and then press ▲[Choose].

The Volumes Infused screen displays the volumes infused on Line A, Line B, and the Total Volume infused on both lines since the last time the values were cleared.

A	Volumes Infused		B
	Heparin	locane	
	25,000 units 250 mL	500 mg 250 mL	
	Line A	4 mL	
	Line B	5 mL	
	Total Volume	9 mL	
Clear A, Clear B or Clear Total?			
	Clear A	Clear B	Clear Total
			Previous Screen

3. To return to the Settings/Vols/CCA screen without clearing any values, press ▲[Previous Screen]. Press ▲[Previous Screen] again to return to the delivery screen.

(The screen will automatically time out after 30 seconds and return to the delivery screen if you do not press a softkey.)

4. To clear the Volumes Infused data:
  - Press ▲[Clear A] to clear the Line A total only.
  - Press ▲[Clear B] to clear the Line B total only.
  - Press ▲[Clear Total] to clear all values, including the Total Volume, and return to the Settings/Vols/CCA screen.
  - Press ▲[Previous Screen] to return to the Settings/Vols/CCA screen.

If you do not press a key in 30 seconds, the Delivery screen automatically returns.

For software versions 15.02 and 15.20 and later, clearing the volume infused totals on this screen also clears the associated volume infused total(s) on the delivery screen.

For software versions 15.10 and 15.11, clearing the volume infused totals on this screen does NOT clear the associated volume infused total(s) on the delivery screen.

## Adjusting Display Lighting and Contrast

You can adjust the lighting and contrast on the infuser display screen to ensure visibility and customize the level for the surrounding environment.

### To adjust display lighting and contrast:

1. On the main delivery screen, press ▲[Settings/Vols/CCA] to display the Settings/Vols/CCA screen shown on page 3-25.
2. Use [SELECT] to highlight Lighting/Contrast and press ▲[Choose]. The Light/Contrast screen appears, with Backlight Intensity highlighted.
3. Use ▲[Increase Setting] and ▲[Decrease Setting] to adjust the backlight intensity.
4. Press [SELECT] to highlight Display Contrast.
5. Use ▲[Increase Setting] and ▲[Decrease Setting] to adjust the display contrast.
6. Press ▲[Done] to save the current settings and return to the Settings/Vols/CCA screen or press ▲[Previous Screen] to leave this screen without saving changes.

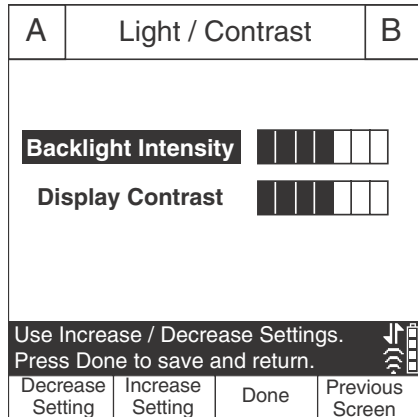

Press ▲[Previous Screen] to return to the Settings/Vols/CCA screen.

## Viewing CCA and Infuser Settings

CCA/Infuser settings set defaults and limits that are appropriate for the patient population of each Clinical Care Area (CCA) or per facility preference.

- For systems with ICU Medical MedNet software, CCA/Infuser settings are configured through the ICU Medical MedNet software. The settings are downloaded to all infusers over the network through a wireless or Ethernet connection.
- For systems without ICU Medical MedNet software, CCA/Infuser settings are configured for each infuser through a special Biomed menu (*see the Plum 360 Infuser Technical Service Manual*).

To view CCA/Infuser settings when you select or change a CCA, press ▲[CCA Details] on the Select CCA screen. You can also view the CCA settings for the current CCA from the Settings/Vols/CCA menu. The following procedure describes how to do this.

**To view the current CCA and Infuser settings:**

On an infuser with a DDL, the CCA is set by a biomed technician. You cannot select a CCA on an infuser with a DDL.

1. On the delivery screen, press ▲[Settings/Vols/CCA] to display the Settings/Vols/CCA menu shown on page 3-25.
2. Select ▲[CCA Settings] and press ▲[Choose]. The CCA Settings screen displays.
3. Press ▲[Page Down] and ▲[Page Up] to view all the CCA and Infuser settings.
4. When you are finished, press ▲[Previous Screen] to return to the Settings/Vols/CCA screen. Press ▲[Previous Screen] again to return to the delivery screen.

CCA Settings		
CCA settings:	Medical	ICU1
Maximum Rate:	999	mL/hr
Maximum VTBI:	9999	mL
Maximum Patient Weight:	500	kg
Minimum Patient Weight:	0.1	kg
Maximum Patient Height:	305	cm
Minimum Patient Height:	7.5	cm
Maximum Patient BSA:	7.07	m2
Minimum Patient BSA:	0.012	m2
Page Down / Up to view all 		
Page Up	Page Down	Previous Screen

**NOTE:** Image represents software version 15.20. For software versions 15.02 through 15.11, screen content varies.



## CCA/Infuser Setting Descriptions

CCA Settings	Description
<b>Maximum Rate</b>	<p>The highest rate that you can program for a single line or Piggyback delivery.</p> <p>For Concurrent delivery, the total rate for Line A + Line B must be <math>\leq 500</math> mL/hr. If this exceeds the maximum rate per line (for example, if the maximum rate is set to 200 mL/hr), then the maximum rate is enforced.</p>
<b>Maximum VTBI</b> (software versions 15.20 and later)	<p>The largest VTBI that you can program for a single line or Piggyback delivery.</p> <p>The Maximum VTBI is defined in the drug library.</p>
<b>Maximum Patient Weight</b> <b>Minimum Patient Weight</b>	<p>Together, these display the allowable patient weight range for the CCA when you program a weight-based or BSA-based delivery.</p> <p>See <a href="#">Patient Data Limits</a> on page 14-12 for the increments that can be programmed for different weight ranges.</p>
<b>Maximum Patient Height</b> <b>Minimum Patient Height</b>	<p>Together, these display the allowable patient height range for the CCA when you program a weight-based or BSA-based delivery.</p> <p>See <a href="#">Patient Data Limits</a> on page 14-12 for the increments that can be programmed for different height ranges.</p>

CCA Settings	Description
<p><b>Maximum Patient BSA</b> <b>Minimum Patient BSA</b></p>	<p>Together, these display the allowable patient BSA range for the CCA when you program a BSA-based delivery.</p> <p>See <b><i>Patient Data Limits</i></b> on page 14-12 for the increments that can be programmed for different BSA ranges.</p>
<p><b>Default Distal Alarm Pressure</b></p>	<p>Displays the normal Distal Alarm Pressure Limit for the CCA. You can change this value for a delivery, when needed.</p> <p>See <b><i>Setting the Distal Pressure Alarm Limit</i></b> on page 3-37 for more information.</p>
<p><b>Default End of Infusion</b> (software versions 15.20 and later)</p>	<p>Sets the rate of infusion after VTBI is delivered to either KVO (Keep Vein Open) or Rate.</p> <p>See <b><i>Setting the Post Infusion Rate</i></b> on page 3-24 for more information.</p>
<p><b>Default Line B Mode for No Drug Selected and Label Only Medications</b> (software versions 15.20 and later)</p> <p><b>NOTE:</b> This setting does not display on the CCA Settings screen.</p>	<p>Sets the initial Line B delivery mode to Piggyback or Concurrent for No Drug Selected and Label Only Medications in the CDL. Default is Piggyback. You can change this mode any time you program a delivery on Line B by selecting the Post Infusion Rate option on the Settings/Vols/CCA screen.</p>

CCA Settings	Description
<b>Distal Alarm Resets</b>	<p>Displays the number of times that the infuser will restart delivery automatically when a distal occlusion is resolved within 60 seconds.</p> <p>Set by a biomedical technician or the CCA in the ICU Medical MedNet software. Default setting is 0.</p> <p><b>NOTE:</b> This feature is disabled for the CCA if Distal Alarm Resets = 0.</p>
<b>Allow Standby</b>	<p>If Allow Standby = Yes, deliveries can be put into Standby up to the configured Maximum Standby Time which is between 24 and 72 hours. (Default is 72 hours.)</p> <p>If Allow Standby = No, ▲[Standby] will not appear on the Program screen.</p>
<b>Allow Delayed Start</b>	<p>If Allow Delayed Start = Yes, you can program a Delayed Start of up to 23:59 hh:mm for deliveries.</p> <p>If Allow Delayed Start = No, ▲[Delay] will not appear on the Program screen.</p>

Infuser Settings	Description
<p><b>Default End of Infusion</b> (software versions 15.11 and earlier)</p>	<p>Sets the rate of infusion after VTBI is delivered to either KVO (Keep Vein Open) or Rate. See <a href="#">Setting the Post Infusion Rate</a> on page 3-24 for more information.</p>
<p><b>Default B Delivery Mode</b> (this setting applies only if the DDL is being used in software versions 15.20 and later)</p>	<p>Sets the initial Line B delivery mode to Piggyback or Concurrent. Default is Piggyback. You can change this mode any time you program a delivery on Line B by pressing <b>▲[Change Mode]</b>.</p>
<p><b>Default Nurse Callback</b></p>	<p>When Default Nurse Callback = Yes, a medium priority alarm will be issued automatically at the end of:</p> <ul style="list-style-type: none"> <li>• any step but the last step of Multistep delivery,</li> <li>• a Loading Dose delivery,</li> <li>• a Piggyback infusion, or</li> <li>• a Bolus delivery.</li> </ul> <p>The user can change the Callback setting from the default setting of Yes.</p> <p>When Default Nurse Callback = No, a Callback Alarm must be set manually, if needed, for each of these.</p>
<p><b>Maximum Standby Time</b></p>	<p>This is the maximum time that a delivery can remain in Standby before the infuser issues a high priority Inactivity alarm. The Maximum Standby Time is defined in the drug library. The available range is 24 to 72 hours, with a default of 72 hours.</p>

## Changing the Default Infuser Settings

CCA settings are set based on the patient population and cannot be changed. Infuser settings that begin with “Default” can be adjusted for a particular delivery, if clinically necessary.

- To change the Distal Alarm Pressure Limit from the preset Default Distal Alarm Pressure, see [Setting the Distal Pressure Alarm Limit](#) on page 3-37.
- To change the Post Infusion Rate from the value set by the Default End of Infusion setting, see [Setting the Post Infusion Rate](#) on page 3-24.
- To change the Line B delivery mode from the Default Line B Delivery Mode setting, see [Programming](#) on page 5-1.
- To set a Nurse Callback Alarm for a Multistep, Loading Dose, Piggyback delivery, or Bolus delivery, see [Programming a Callback Alarm](#) on page 3-20.

## Setting the Distal Pressure Alarm Limit

The distal pressure limit sets the threshold for the distal occlusion alarm. When the infuser detects that the distal pressure in the cassette sensor area is greater than the distal pressure limit you set,  $\pm 3$  psi, the infuser issues an alarm (see [Restarting the Delivery Automatically After a Distal Occlusion Alarm](#) on page 3-20 for more information).

The infuser checks the distal pressure and updates the reading every second. You can view the distal pressure reading on the same screen where you set the distal pressure limit.



---

**WARNING**

**BEFORE STARTING A DELIVERY, VERIFY THE DISTAL PRESSURE ALARM LIMIT OR SET THE APPROPRIATE LIMIT FOR THE PATIENT, FLOW RATE AND ADMINISTRATION SET.**

---

**To view the current distal pressure reading and set the distal pressure limit:**

1. On the main delivery screen, press ▲[Settings/Vols/CCA] to display the Settings/Vols/CCA screen shown on page 3-25.
2. Use [SELECT] to highlight Pressure and press ▲[Choose] to view. Upon completion, select ▲[Done] or ▲[Previous Screen] to return to the Settings/Vols/CCA screen; then press ▲[Previous Screen] to return to the main delivery screen.

A	Pressure	B
	Distal Pressure Alarm Limit	6 psi
	Current Distal Pressure	1.5 psi
Enter value using keypad. Press Done to save and return.		
	Done	Previous Screen



Check the Distal Occlusion alarm setting before each patient use to ensure that the setting is correct for the current patient.

**To change the Distal Pressure Alarm Limit:**



**CAUTION** 

---

**DO NOT SET THE DISTAL PRESSURE ALARM LEVEL LOWER THAN 3 PSI (155 MMHG) OR HIGHER THAN 12 PSI (624 MMHG). SETTING THE ALARM OUTSIDE OF THAT RANGE MAY RESULT IN UNRELIABLE ALARM FUNCTIONING.** 

---

1. If the infuser is running, stop the infusion.
2. Press ▲[Settings/Vols/CCA] to display the Settings/Vols/CCA screen.
3. Use [SELECT] to highlight Distal Pressure Alarm Limit and press ▲[Choose].

4. Change the limit to the desired PSI value between 3 and 12 (between 155 and 634 mmHg).
5. Use the keypad to press ▲[Done] to save your changes and return to the Settings/Vols/CCA screen or press ▲[Previous Screen] to view the settings without making changes.
6. Press ▲[Previous Screen] to return to the main delivery screen.

## Changing the Default Line B Delivery Mode

### To change the default Line B delivery mode:

1. Press ▲[B] to choose Line B. The Program screen appears, displaying No Drug Selected.
2. Choose a drug and associated dosing units, if applicable.
3. Choose a dosing unit (the default is mL/hr) to display the Program screen.
4. Navigate to the current Mode field (displaying Piggyback or Concurrent), then ▲[Change Mode].
5. Press [START] for confirmation when all program parameters have been populated, then ▲[Yes] to start delivery.

---

---

# Notes

---

---



## Section 4

# Plum Administration Sets

Plum 360 infuser operation requires single-use Plum series administration sets (PlumSets). See [Administration Sets](#) on page 12-1 for a representative list of Plum administration sets.



### CAUTION

**PLUM ADMINISTRATION SETS ARE NOT FOR USE WITH HIGH PRESSURE INFUSION.**

The following illustration shows the parts of a typical Plum primary I.V. administration set.

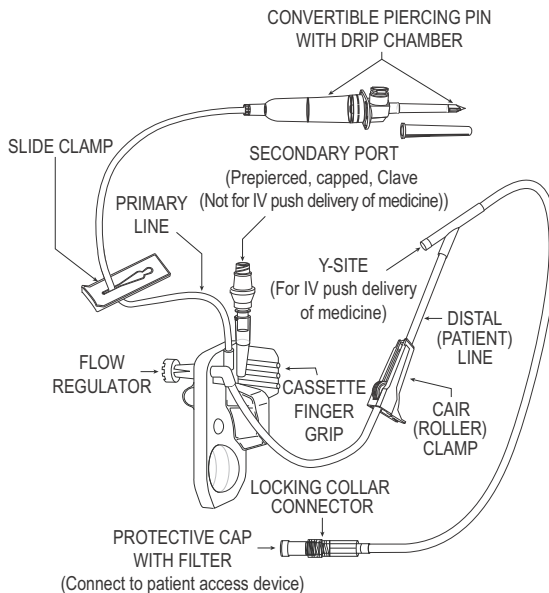

Plum administration sets have a 96-hour performance limit. Refer to the set packaging or facility policy for guidelines on when to change the set.

See [Plum Administration Sets](#) on page 2-14 for more information about administration set features. See [Administration Sets](#) on page 12-1 for a representative list of Plum administration sets.

## Priming a Primary Administration Set

*Priming* fills the cassette, tubing, and any other special features of the set with fluid, displacing air. Proper priming is an important part of air management.

The following procedure gives the general steps for priming a Plum administration set. Refer to the administration set packaging for complete instructions on how to prime the set.



---

**WARNING**

**DO NOT PRIME THE ADMINISTRATION SET WHILE IT IS CONNECTED TO A PATIENT.**

---



---

**WARNING**

**DO NOT RESTERILIZE OR REUSE ADMINISTRATION SETS. ADMINISTRATION SETS ARE SINGLE-USE ONLY. RESTERILIZATION OR REUSE OF THE SETS MAY RESULT IN INACCURATE DELIVERY, INFECTION, AND ALLERGIC REACTION.**

---

Sterile administration sets are indicated on the administration set packaging. Refer to the packaging for the method of sterilization.



---

**WARNING**

**USE ONLY ICU MEDICAL PLUM ADMINISTRATION SETS WITH A CASSETTE SPECIFIED FOR USE WITH THE PLUM INFUSER. USE OF NON-PLUM CASSETTES CAN RESULT IN IMPROPER FUNCTIONING OF THE INFUSER OR INACCURATE DELIVERY.**

---

**WARNING**

**INSPECT THE ADMINISTRATION SET PACKAGING. IF THE PACKAGING IS NOT INTACT, DISCARD IT AND USE A NEW SET.**



Do NOT use a Plum administration set for longer than 96 continuous hours. Change sets per set package labeling or facility policy. Administration sets are single-patient use only.

**To prime a Plum administration set:**

Use aseptic technique with all fluid path connections to prevent contamination and infection. Remove caps when required and secure all connections.

1. Attach the infuser to a compatible I.V. Pole (see [Mounting the Infuser on an I.V. Pole](#) on page 3-3) or place the infuser on a flat, stable surface.
2. Inspect the administration set packaging. If the packaging is not intact, discard it and use a new set.
3. Open the package and remove the administration set.
4. Press the cassette flow regulator in to make sure it is closed and confirm that there is no flow during priming.

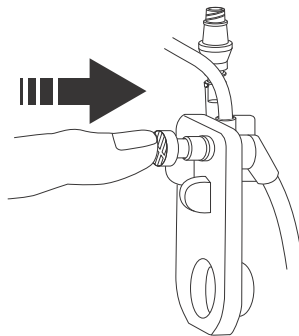



**CAUTION** 

---

**BE CAREFUL WHEN PIERCING THE SOLUTION CONTAINER TO AVOID PUNCTURING IT.** 

---

5. Insert the piercing pin into the outlet on the fluid container using a twisting motion.

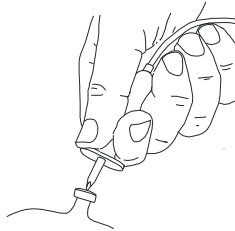

Do not insert the piercing pin while the container is hanging above the infuser.

6. Suspend the container on an I.V. Pole.



**CAUTION** 

---

**CHECK THE CONTAINER FOR LEAKS. IF ANY PART OF THE CONTAINER IS LEAKING, REPLACE IT.** 

---

7. Squeeze the drip chamber to the score mark. Do not completely fill the drip chamber.

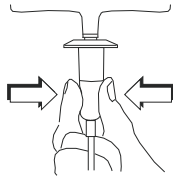

8. If using a rigid fluid container (glass bottle, for example), open the filter vent cover above the drip chamber. If using a flexible plastic container, make sure this vent cover is closed.

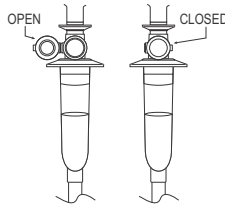

9. Invert the cassette so that the secondary port is pointing down.

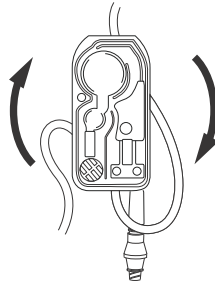

10. **Slowly** open the flow regulator by turning it counter-clockwise while holding the cassette in the inverted position, to allow the fluid to flow into the cassette at a controlled rate.

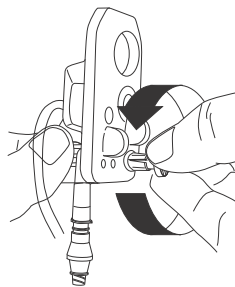

**NOTE:** To quickly stop the flow at any time, push in on the flow regulator.

11. When the first drop appears in the pumping chamber, turn the cassette upright.

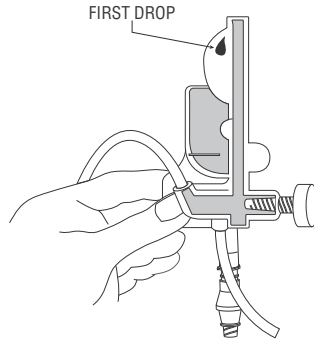

12. Continue to slowly prime the set until all air is removed from the cassette and the remainder of the tubing.
  - Tap the cassette and tubing to dislodge air bubbles.

**NOTE:** Invert and tap each Y-site to fill it with fluid, as shown in the following figure, and then turn the Y-site upright.

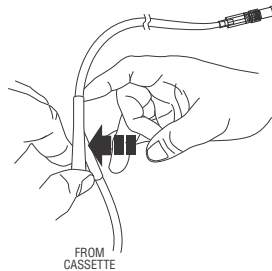

- If the filter at the distal (patient) end of the tubing gets wet, you must temporarily remove the cap to continue priming.

13. Once priming is complete, push the flow regulator in to close it.

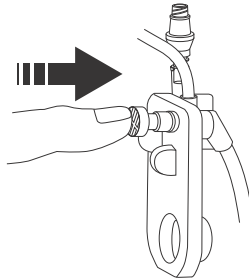

**CAUTION**

**CHECK THE DRIP CHAMBER AND THE DISTAL END OF THE TUBING TO CONFIRM THAT THERE IS NO FLOW AND THAT NO KINKS APPEAR IN THE TUBING. IF YOU OBSERVE FLOW OR LEAKS, CLOSE ALL CLAMPS AND REPLACE THE ADMINISTRATION SET.**

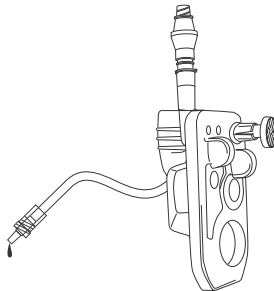

The cassette is now ready to load into the infuser.

# Loading a Cassette

To load a primed cassette into the infuser:

1. Lift the lever to open the cassette door.

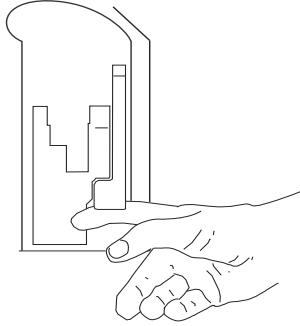

2. Grasp the cassette by the finger grip.

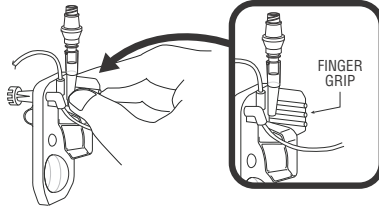

3. Slide the cassette between the cassette door and the door guides.

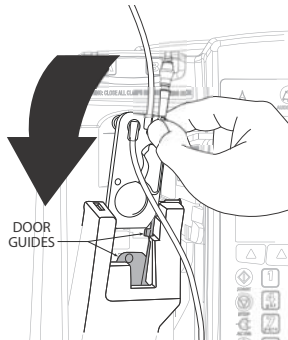



- Press the lever down to close the cassette door.

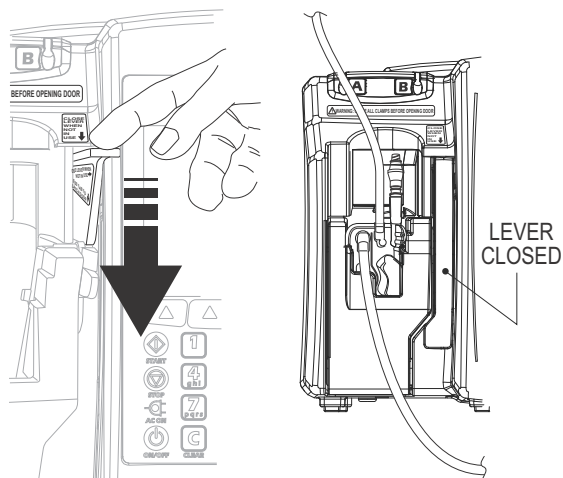

- Insert the proximal line into the Line A tubing guide.
- Open all clamps.



### CAUTION

**CHECK THE DRIP CHAMBER AND THE DISTAL END OF THE TUBING TO CONFIRM THAT THERE IS NO FLOW AND THAT NO KINKS APPEAR IN THE TUBING. IF YOU OBSERVE FLOW OR LEAKS, CLOSE ALL CLAMPS AND REPLACE THE ADMINISTRATION SET.**

- Press [ON/OFF] to turn on the infuser.
- After the infuser completes its startup sequence, insert the connector on the distal tubing into the patient access device. Move the locking collar over the connection. Turn the collar clockwise to secure the tubing to the patient access device.



### WARNING

**ARRANGE ALL TUBING, CORDS, AND CABLES TO MINIMIZE THE CHANCE OF PATIENT STRANGULATION OR ENTANGLEMENT.**

- Program a delivery on Line A. See [Programming](#) on page 5-1 or [Delivery Options](#) on page 8-1 for instructions.

# Preparing a Secondary Delivery from an Administration Set

The following procedure gives the general steps for preparing a secondary administration set for a Piggyback or Concurrent delivery. Refer to the set packaging for complete instructions on how to prime the administration set you are about to use.



**WARNING**  
**ENSURE MEDICATIONS THAT ARE DELIVERED CONCURRENTLY OR IN PIGGYBACK, ARE COMPATIBLE.**



**WARNING**  
**USE ONLY ICU MEDICAL PLUM ADMINISTRATION SETS.**



**WARNING**  
**DO NOT RESTERILIZE ADMINISTRATION SETS.**



**WARNING**  
**DO NOT REUSE ADMINISTRATION SETS. REUSE MAY RESULT IN INFECTIONS AND ALLERGIC REACTIONS. REUSE MAY ALSO RESULT IN INACCURATE FLOW RATES.**



Use aseptic technique with all fluid path connections to prevent contamination. Remove caps when required and secure all connections.

**NOTE:** You do not need to remove the primary administration set from the infuser or detach it from the patient before attaching a primed secondary administration set.

## To prime a secondary administration set:

1. Inspect the set packaging. If the packaging is not intact, discard it and use a new set.

2. Open the set packaging and remove the set. Make sure the roller clamp on the set is in the closed position.

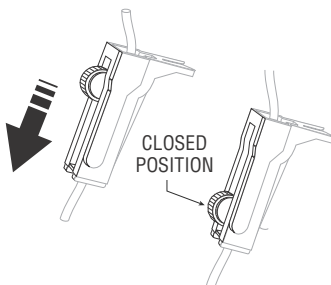

---

**CAUTION**

**BE CAREFUL WHEN PIERCING THE SOLUTION CONTAINER TO AVOID PUNCTURING IT.**

---

3. Insert the piercing pin into the secondary container outlet using a twisting motion.



Do not insert the piercing pin while the container is hanging above the infuser.

4. Suspend the container on an I.V. Pole.



---

**CAUTION**

**CHECK THE SECONDARY CONTAINER FOR LEAKS. IF ANY PART OF THE CONTAINER IS LEAKING, REPLACE IT.**

---

5. Squeeze the drip chamber to fill it about 1/3 full or to the score mark. Do not completely fill the drip chamber.

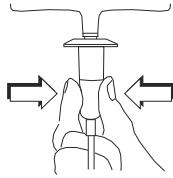

6. If using a rigid fluid container (glass bottle, for example), open the filter vent cover above the drip chamber. If using a flexible plastic container, make sure this vent cover is closed.

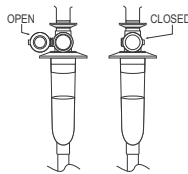

7. **Slowly** open the roller clamp to allow fluid to flow into the secondary tubing at a controlled rate.

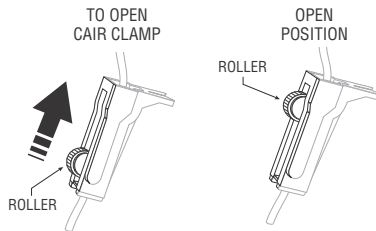

- After all air is removed, close the roller clamp.

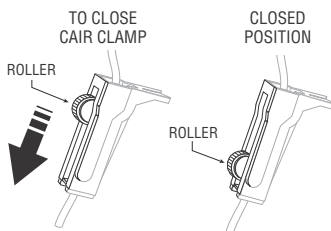

- Attach the line to the secondary port (see [Connecting a Secondary Line or Syringe](#) on page 4-13).
- Insert the secondary line into the Line B tubing guide.



**WARNING**  
**ARRANGE ALL TUBING, CORDS, AND CABLES TO MINIMIZE THE CHANCE OF PATIENT STRANGULATION OR ENTANGLEMENT.**

- Open all clamps. Check that no kinks appear in the tubing.
- Program the delivery on Line B (see [Programming Line B](#) on page 5-2).

## Connecting a Secondary Line or Syringe

A primary PlumSet may have a Clave, prepierced, or capped connector on the secondary port. The following sections describe how to attach a secondary line or syringe to each secondary port type.



Use aseptic technique with all fluid path connections to prevent contamination. Remove caps when required and secure all connections.

## Connecting to a Clave Port

The Clave is a needle-free connector with an internal design that prevents leakage from the top of the connector. The secondary line or syringe can be attached directly to the port. Avoid twisting or bending the port during attachment to prevent damage or breakage.

### To connect a line or syringe to a Clave secondary port:

1. Grasp the base of the Clave connector to support it, and then insert the end of the secondary line or syringe into the Clave.

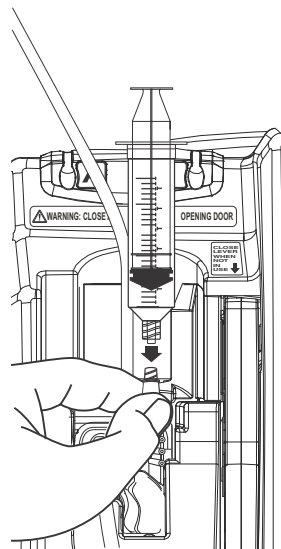
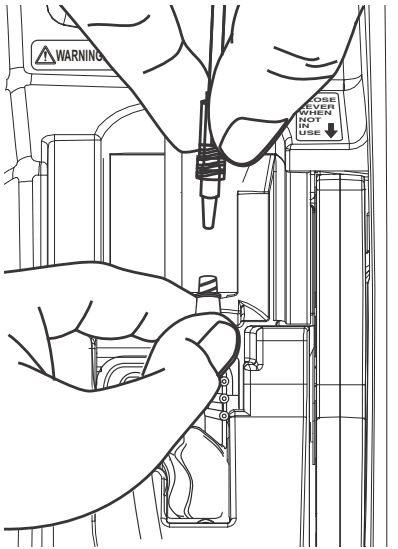

**NOTE:** Do not twist or bend the Clave when accessing the secondary port.

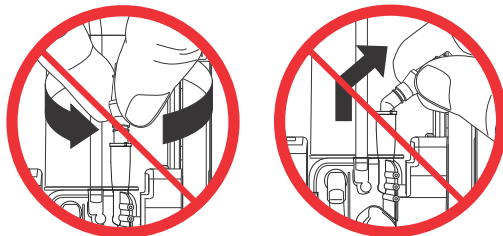

## 2. Secure the connection:

- If attaching a secondary line, continue to support the Clave with one hand as you move the locking collar over the port with the other hand and twist the collar clockwise to secure the line.

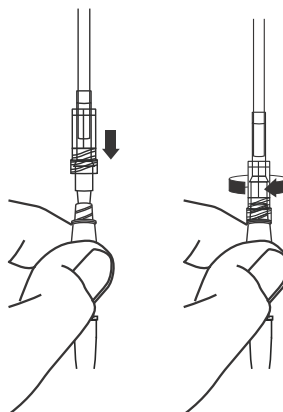

- If attaching a Luer-Lok syringe or syringe adapter, continue to support the Clave connector with one hand as you twist the Luer-Lok or adapter connector clockwise with the other hand to lock the connection in place.

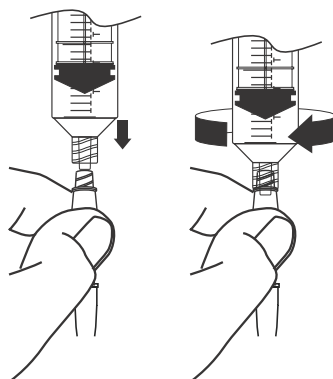

## Connecting to a Pierced Port

The pierced port requires a locking blunt cannula to provide needle-free access and a secure connection.

### To connect a line or syringe to a pierced port:

1. Remove the protective sleeve from the locking blunt cannula.

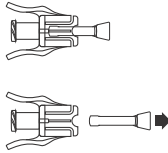

2. Insert the connector on the secondary line or syringe into the locking blunt cannula, and then twist the locking collar on the line to secure the connection.

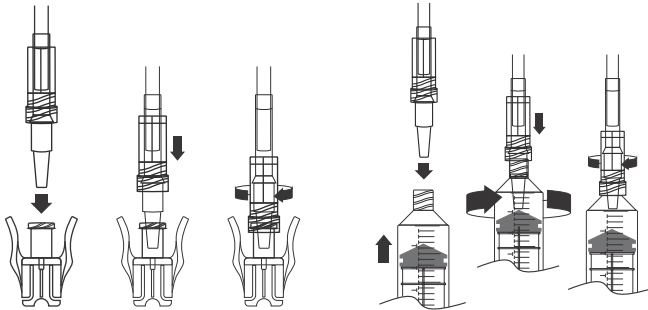

**NOTE:** If using a syringe adapter, attach the adapter to the syringe and then attach the locking blunt cannula to the adapter.



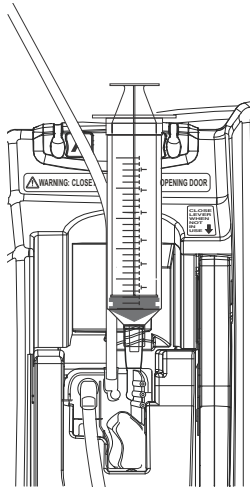

3. Center the cannula over the prepierced secondary port and push until the cannula clicks into place.

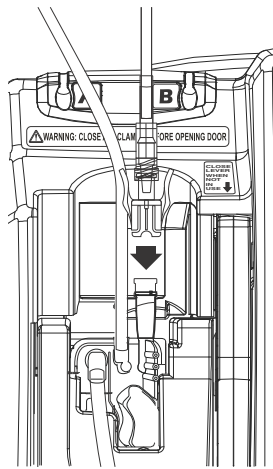

4. Gently pull the connection between the secondary line or syringe and the locking blunt cannula to confirm that all connections are secure.

## Connecting to a Capped Port

A secondary line or syringe attaches directly to the capped port. To prevent leakage from the top of the connector during the following procedure, you must ensure that the cassette door remains closed or clamp the primary line (Line A) before opening the cassette door.

### To connect a line or syringe to a capped port:

1. Confirm that the cassette door is closed, to prevent leakage.
2. Loosen, remove, and discard the cap.

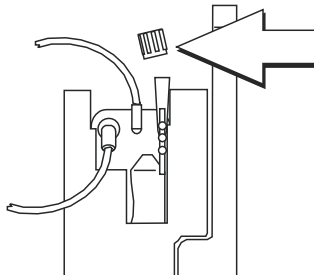

**WARNING**  
**CLOSE THE CLAMP ON PROXIMAL LINE A TO PREVENT FLUID FROM SPILLING IF YOU MUST OPEN THE CASSETTE DOOR TO REMOVE THE CAP.**

3. Insert the connector on the secondary line or syringe into the secondary port.
4. Secure the connection:
  - If attaching a secondary line, move the locking collar over the port and twist the collar clockwise to secure the line.
  - If attaching a Luer-Lok syringe or syringe adapter, twist the Luer-Lok or adapter connector clockwise to lock it in place.

## Priming the Syringe Adapter

To prime the syringe adapter:

1. Fill the syringe with solution.
2. Attach the vented syringe adapter onto syringe.
3. Press on the syringe plunger until the vented syringe adapter fills up and fluid is seen at the open end of the syringe adapter.
4. Refill the syringe, if necessary.

## Preparing a Secondary Delivery from a Syringe



**WARNING** —————  
**ENSURE MEDICATIONS THAT ARE DELIVERED  
CONCURRENTLY OR IN PIGGYBACK ARE COMPATIBLE.**

---

**NOTE:** Access ports on the Plum cassette are NOT for I.V. push delivery of medication. Ports are only for infuser-controlled delivery of medication.

You can attach a syringe to the secondary port on a Plum cassette for Piggyback or Concurrent delivery of a secondary fluid. Follow these guidelines:

<p><b>Syringe sizes accepted:</b></p>	<p>3 mL - 60 mL</p> <p>Small volume syringes, i.e., 3-10 mL, require a vented syringe adapter to ensure delivery accuracy and reduce proximal occlusion alarms.</p> <p>Syringes larger than 10 mL do not require a syringe adapter.</p>
<p><b>Attaching to a Clave or capped secondary port:</b></p>	<p>Attach the syringe directly to the port. If using a syringe adapter, attach the adapter to the syringe and prime the adapter before attaching the syringe/adapter assembly to the port (see <a href="#">Connecting a Secondary Line or Syringe</a> on page 4-13).</p>
<p><b>Attaching to a prepierced secondary port:</b></p>	<p>Fit the syringe with a locking blunt cannula before attaching to the port.</p> <p>If using a syringe adapter, attach the adapter to the syringe and prime the adapter, and then attach the locking blunt cannula to the adapter before attaching the syringe/adapter/cannula assembly to the port (see <a href="#">Connecting to a Prepierced Port</a> on page 4-16).</p>

You do not need to remove the primary administration set from the infuser or the patient before attaching a syringe to the secondary port.

# Backpriming



**CAUTION**  
**DURING BACKPRIMING, FLUIDS CAN BECOME MIXED AND DILUTED.**



Backpriming should not be performed for reconstituting secondary containers containing dry powders.

**NOTE:** A small amount of fluid may be expelled from the set (less than or equal to 0.05 mL) after backpriming. If potent drugs are being used, take appropriate action to guard against over-medication of the patient.

Backpriming resolves proximal air-in-line alarms on Line A or Line B without the need to disconnect the administration set from a patient. Backpriming can also relieve built-up pressure in the cassette caused by some occlusion conditions, resolving the occlusion alarms while the patient is still connected to the set. However, backpriming is not necessary to clear alarms. After an obstruction or occlusion is resolved, pressing [START] clears an alarm. See [Alarms and Troubleshooting](#) on page 9-1 for alarms that can be resolved by backpriming.

During a backprime, fluid is pumped from the container on Line A to a line or syringe attached to the secondary port (Line B) at a rate of approximately 1 mL every 5 seconds. In the process, air is cleared from the cassette air trap and proximal line(s). The infuser closes valves to ensure that the backprimed fluid never reaches the patient.

## Preparing to Backprime

To accept the backprimed air and/or fluid, a line with a container or syringe must be attached to the secondary port. This attachment prevents proximal occlusion alarms on the secondary line during the backprime operation.

**NOTE:** If you are using a syringe adapter, you must open and close the lever before you will be able to backprime.

### Setup for Backpriming into a Secondary Line

If you already have a delivery set up for Line B, you can backprime into the Line B fluid container. This setup will resolve a proximal air-in-line alarm for either Line A or Line B.

**NOTE:** Since the Plum 360 infuser delivers the exact VTBI that is programmed for a line, you may need to adjust the VTBI on Line B to account for the extra volume from backprimed fluid.

The following illustration shows how the Line A fluid mixes with the Line B fluid during a backprime. Notice that the fluid path from the pumping chamber to the patient contains only Line A fluid.

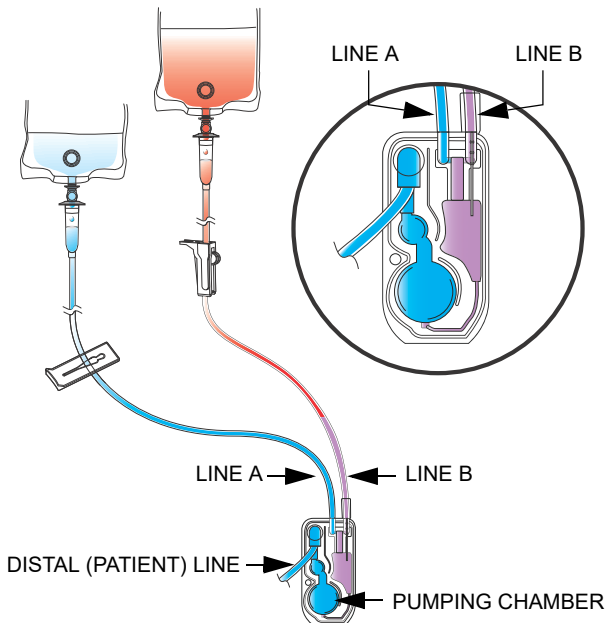

## Setup for Backpriming into a Syringe

If you do not have a delivery set up on Line B, or you need to avoid pumping air and fluid from Line A into Line B, you can attach a syringe to the secondary port to accept the fluid and/or air from Line A and the cassette when backpriming.

**NOTE:** Before you begin a backprime, ensure that the syringe has enough free space to accept the backprimed fluid. Backpriming into a full syringe will trigger a proximal occlusion alarm.

The illustration shows the setup for backpriming into a syringe.

For instruction on how to attach a syringe to a secondary port on the cassette, see [Preparing a Secondary Delivery from a Syringe](#) on page 4-19.

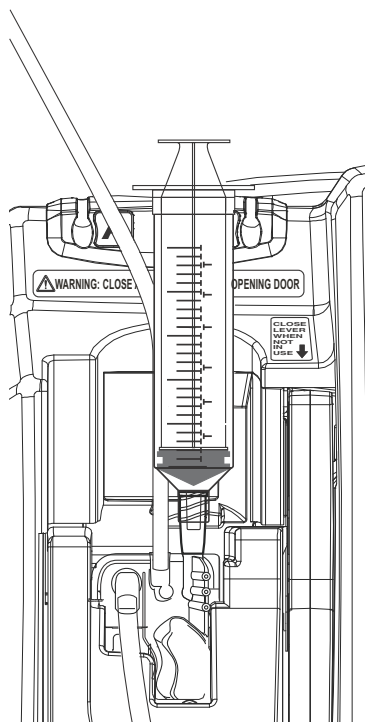

## Backpriming Procedure

Before you begin a backprime, ensure that there is a line or syringe on the secondary port and a secondary container to accept the backprimed fluid and expelled air (see [Preparing to Backprime](#) on page 4-22).

**To backprime:**

1. Press and hold ▲[Back Prime] until fluid pumped from Line A to Line B clears air from the cassette and from Line B (if present).

When you release ▲[Back Prime] the infuser performs a cassette test.

**NOTE:** If you press and hold the ▲[Back Prime] key for two minutes, a stuck key alarm sounds and the display screen shows **Power Off then On. Replace pump if alarm continues.**

2. If the cassette test detects that there is still air in the line, repeat Step 1 until the cassette test is successful.
3. Press [START] to restart the delivery. If two lines were pumping when delivery stopped, press the appropriate softkey in response to the prompt (see *Stopping and Restarting a Delivery on page 3-22*).

**If you do not see ▲[Back Prime]:**

▲[Back Prime] is available only on the delivery screen and only when delivery is stopped. (Delivery stops automatically when there is an alarm that can be resolved by backpriming.)

- If the cassette test fails while the New Patient? prompt is displayed, press ▲[Yes] or ▲[No], as appropriate, and then hold down ▲[Back Prime] to clear air from the cassette.
- If the cassette test fails while the CCA Selection screen is displayed, choose the correct CCA. The infuser displays the delivery screen, where ▲[Back Prime] is available.
- If the infuser alarms and stops while you are viewing a screen other than the delivery screen (for example, Line A stops due to an air-in-line alarm while you are programming Line B) navigate to the delivery screen and then press ▲[Back Prime].



# Discontinuing Electronic Flow Control and Setting Gravity Flow



---

**CAUTION**

**CONSULT INDIVIDUAL ADMINISTRATION SET INSTRUCTIONS FOR USE FOR ANY RESTRICTIONS REGARDING GRAVITY USE.**

---

Gravity flow allows you to temporarily continue fluid delivery without the Plum 360 infuser.

**NOTE:** Gravity flow is supported for only one line. When using gravity flow to deliver fluid, only deliver from one fluid container at a time.



---

**WARNING**

**CLOSE ALL CLAMPS BEFORE OPENING THE CASSETTE DOOR.**

---

## To discontinue fluid flow and set gravity flow:

1. Press [STOP]. If two lines were pumping, press ▲[Stop All].
2. Press [ON/OFF] to turn off the infuser.
3. Close all clamps.
4. Open the cassette door and remove the cassette.

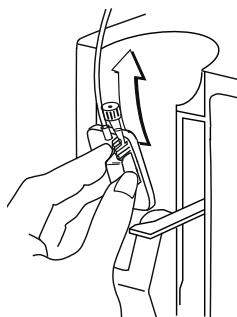

5. **If only 1 line was pumping**, open all clamps.

**If 2 lines were pumping**, you must choose one line for gravity flow. Open the clamps on that proximal line and on the distal line. Make sure one proximal line stays clamped.

6. Holding the cassette upright, set gravity flow by turning the flow regulator counter-clockwise.

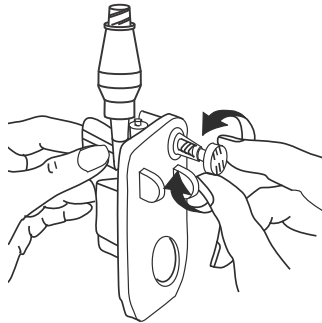

**NOTE:** If the line is equipped with a roller clamp, you can use the clamp to control the flow rate. To do this, close the roller clamp, open the flow regulator completely, and then gradually open the roller clamp to adjust the flow.

7. Check the drip chamber to measure the flow rate. Refer to the administration set package for the number of drops/mL, or see [Administration Sets](#) on page 12-1 for a representative list of Plum administration sets with information on drops/mL.

**To resume delivery in a replacement infuser:**

1. Close all clamps.
2. Insert the cassette into the infuser and close the door.
3. Open all clamps.
4. Check the drip chamber to ensure that there is no flow.

If you see flow, close all clamps and replace the set. If you still see flow from a replacement set, replace the infuser.

5. Turn on the infuser.
6. Program the delivery.
7. Start the delivery.

## Removing a Secondary Line or Syringe

The following procedure describes how to disconnect a secondary line or syringe from the Plum cassette.

- You do not need to disconnect the set from the patient during this procedure.
- You also do not need to stop Line A.

**To remove a secondary line or syringe during delivery:**

Use aseptic technique with all fluid path connections to prevent contamination. Remove caps when required and secure all connections.

1. Press [STOP] and then press ▲[Stop B].
2. Remove the syringe or line as follows:
  - **To remove a secondary line from a Clave or capped secondary port** - Clamp the line, twist counterclockwise to release the locking collar, and then pull up to disconnect the line. Aseptically cap a capped secondary port.

- **To remove a syringe from a Clave or capped secondary port** - Pull up the plunger slightly to avoid spilling fluid. Twist counterclockwise to disconnect a Luer-Lok or syringe adapter, if present, and remove the syringe from the port. Aseptically cap a capped secondary port.
  - **To remove a secondary line or syringe from a pierced secondary port** - Pull up the plunger slightly to avoid spilling fluid. Clamp the secondary line (if present), fully depress the levers on the locking blunt cannula, and then pull upward.
3. Discard the secondary line or syringe (with fluid container, if present) per hospital procedure.

## Discontinuing Fluid Administration

The following procedure describes how to remove a primary administration set from the patient, either to discontinue fluid delivery, or to change the set.



Do NOT use a Plum administration set for longer than 96 continuous hours. Change sets per set package labeling or facility policy. Administration sets are single-patient use only.

### To discontinue fluid delivery:

1. Press [STOP]. If two lines are pumping, press ▲[Stop All].
2. Press [ON/OFF] to turn off the infuser.
3. Close all clamps.
4. Detach the distal line from the patient access device.

5. Open the cassette door and remove the cassette.

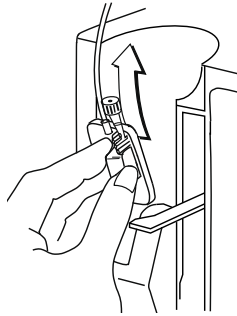

6. Close the cassette door.
7. Discard the set and fluid container per hospital procedure.

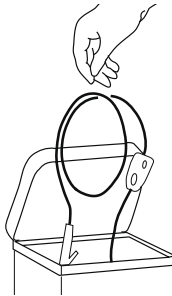

## Changing Administration Sets

Plum administration sets should be changed per facility policy or every 96 hours, whichever is less.

-  Do NOT use a Plum administration set for longer than 96 continuous hours. Change sets per set package labeling or facility policy. Administration sets are single-patient use only.

### To change the administration set:



Use aseptic technique with all fluid path connections to prevent contamination. Remove caps when required and secure all connections.

1. Stop the infuser, close all clamps, and then remove and discard the old set. See [Discontinuing Fluid Administration](#) on page 4-28 for instructions.
2. Prepare and install a new administration set. See [Priming a Primary Administration Set](#) on page 4-2 for instructions.

## Resolving a Distal Air-in-Line Alarm

Use the following procedure to remove air from the distal (patient) line following a distal air-in-line alarm.

### To resolve a distal air-in-line alarm:



Use aseptic technique with all fluid path connections, to prevent contamination, and secure all connections.

1. Close all clamps. If secondary line is attached, clamp the proximal Line B to avoid the mixing of fluids.
2. Disconnect the administration set from the patient.
3. Open the cassette door and remove the cassette.
4. Unclamp the proximal tubing of the line you want to use to prime the distal line.
5. Reprime the administration set to remove the distal air (see [Priming a Primary Administration Set](#) on page 4-2).
6. Insert the cassette into the infuser, close the cassette door, and then open all clamps (see [Loading a Cassette](#) on page 4-8).
7. Reattach the administration set to the patient and restart delivery.

## Avoiding Unintended Bolus While Resolving a Distal Occlusion

When using critical drugs, care must be taken to avoid an unintended bolus. Use the following procedure to avoid the administration of an unintended bolus caused by the buildup of pressure in the cassette caused by a distal occlusion (see [Maximum Unintended Bolus Volume Released After Distal Occlusion is Resolved](#) on page 11-9).

**To resolve a distal occlusion when fluid volume is critical:**

1. Close all clamps.

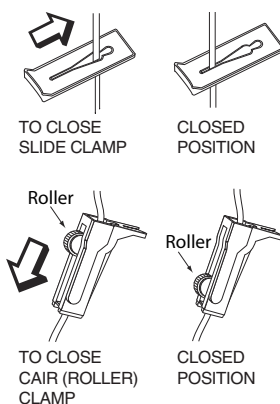

2. Open the cassette door and remove the cassette.

3. Gently pull out the flow regulator on the cassette to dissipate the pressure for a brief moment, and then push in on the flow regulator to close it.

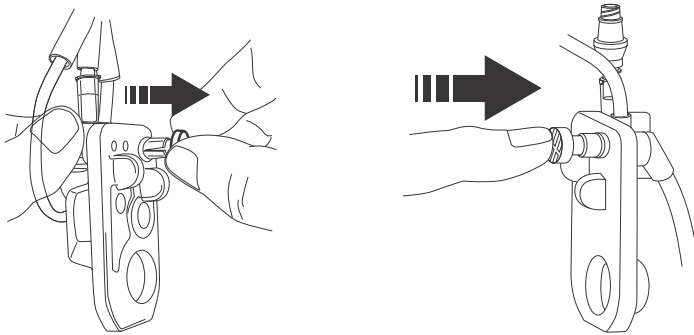

4. Eliminate the source of occlusion.
5. Insert the cassette into the infuser and close the cassette door.

**NOTE:** A small amount of fluid is expelled from the set (less than 0.1 mL) each time the door is opened or closed with a set installed. If potent drugs are being used, take appropriate action to guard against over-medication of the patient.

6. Open all clamps and resume the infusion.



---

## Section 5

# Programming

---

## Programming Features Common to the Default Drug Library and Custom Drug Libraries

### Auto-Calculations

There are three ways that the Plum 360 infuser performs auto-calculations:

- In a time-based dosing unit such as mL/hr or mg/kg/hr, where entering the dose calculates the rate and entering the VTBI calculates the duration.
- In a non-time-based dosing unit such as mg/mL, where entering the dose calculates the VTBI, and entering the rate calculates the duration. Calculated VTBIs are rounded to the nearest 0.1 mL resolution.
- In mL/hr, where there is no dose value entry.

Refer to [Examples of Automatic Calculation](#) on page 7-4 for additional information on how the infuser performs auto-calculations.

### Body Surface Area (BSA) Dosing Unit

A BSA dosing unit is indicated by  $m^2$ , for example,  $mg/m^2/day$ .

BSA can be entered manually or, if you enter a weight and height, it will be automatically calculated.

## Programming Line B



**WARNING** \_\_\_\_\_  
**ENSURE MEDICATIONS THAT ARE DELIVERED CONCURRENTLY, OR IN PIGGYBACK, ARE COMPATIBLE.**

---

When you are programming Line B, you can select a delivery mode of Piggyback or Concurrent as the delivery mode. If you are using a custom drug library, there may be some restrictions.

The following rules apply when programming Line B.

- All software versions:
  - When programming Line B with a non-Piggybackable drug (as defined in the custom drug library), the delivery mode for Line B defaults to Concurrent and cannot be changed.
  - When programming Line B, if there is a confirmed program on Line A with a drug that is non-interruptible, the delivery mode for Line B will default to Concurrent and cannot be changed.
  - If there is a confirmed program on Line A with a medication that is interruptible, the medication on Line B is Piggybackable, and the infusion would result in a concurrency violation, the Line B delivery mode is set to Piggyback and cannot be changed.
- For software versions 15.02 - 15.11:
  - If Line A is not programmed or if Line A is programmed with a medication that is interruptible, the medication on Line B is Piggybackable, and the infusion would not result in a concurrency violation, Line B delivery mode is set based on the Default B Delivery Mode setting and can be changed.
- For software versions 15.20 and later:
  - If Line A is not programmed or Line A is programmed with a medication that is interruptible, the medication on Line B is Piggybackable, and the infusion would not result in a concurrency violation, Line B delivery mode is set as follows and can be changed:

- If the infuser is using the default drug library, the Line B delivery mode is set based on the Biomed Mode Default B Delivery Mode infuser setting.
- If the infuser is using a custom drug library and No Drug Selected has been selected, the Line B delivery mode is set based on the drug library Default B Delivery Mode infuser setting.
- If the infuser is using a custom drug library with a medication other than No Drug Selected, the Line B delivery mode is set based on the drug library Default Line B Mode medication setting.

To change the delivery mode, highlight the current delivery mode on the programming screen and press ▲[Change Mode] to toggle the delivery mode between Piggyback or Concurrent.

To program Line B in Concurrent delivery mode, the delivery rate of Lines A and B must each be greater than or equal to 0.5 mL/hr and the combined delivery rate of both lines must be less than or equal to 500 mL/hr.

If programming a Piggyback delivery on Line B, you can program a Callback alarm to activate when the Piggyback VTBI is complete.

Anytime Line B is in Piggyback mode and Line A is not in a PENDING state, the infuser will notify you that there is a potential for a period of no delivery after the Piggyback VTBI is complete.

## **Programming a Flush for a Piggyback Delivery**

---

The Flush feature enables the clinician to flush the distal tubing volume after a piggyback therapy. The programmed Flush volume is delivered from the Line A container at the Piggyback therapy rate after the Piggyback therapy completes.

Flush programming is available in software versions 15.20 and later.

A flush can be programmed under the following conditions:

- Line A is programmed with a medication that is interruptible

- Line A is programmed with a delivery mode other than Multistep or Loading Dose
- Line A VTBI is greater than 0
- Line B delivery mode is Piggyback
- Line B is **stopped**

Flush duration and volume are not considered when the infuser is checking for Hard Limit or Soft Limit violations for the Line A or Line B programs.

**To program a flush with a new Piggyback delivery under the conditions listed above:**

1. On the Line B Program screen, press ▲[Flush].

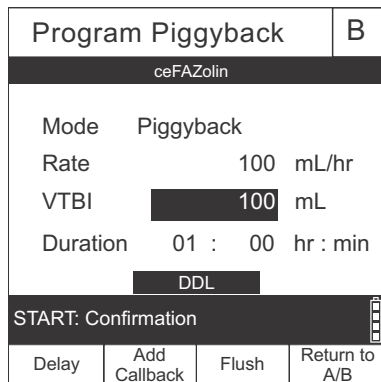

2. Enter a Flush Volume between 5 mL and 30 mL. This is the only editable value on the screen.

If the entered Flush Volume is more than the current VTBI on Line A, you will be required to either increase the VTBI on Line A or decrease the Flush Volume before completing the flush programming.

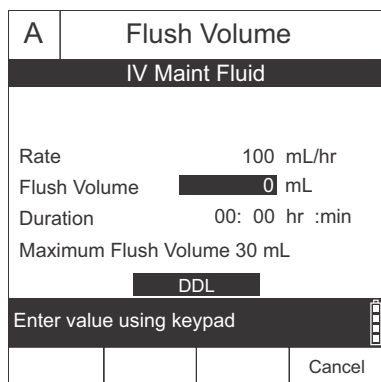

3. Press [START].

- Press **▲**[Yes] to confirm the Piggyback program with a flush and start delivery on Line B.

Confirm Piggyback		B	
ceFAZolin			
⚠			
Rate	100	mL/hr	
VTBI	100	mL	(15mL Flush)
Duration	01 : 00	hr : min	
DDL		Piggyback	
Yes: Start delivery			
No: Edit			
Yes	Standby		No

The Delivery screen displays with Line A PENDING state and Line B PUMPING.

A	PENDING	PUMPING	B
IV Maint Fluid		ceFAZolin	
⚠			
50	Rate	100	
	mL/hr		
1	Vol Inf	0.3	
	mL		
DDL		Piggyback-F	
Select Line A/B to program.			
Select STOP key to Clear.			
Standby	A	B	Settings/ Vols/CCA

When the Piggyback VTBI reaches 0, the flush will be delivered from the Line A container at the Line B Piggyback delivery rate until the flush has been delivered. Line A will display FLUSH.

A	FLUSH	STOPPED	B
IV Maint Fluid		ceFAZolin	
⚠			
100	Rate	100	
	mL/hr		
11	Vol Inf	50	
	mL		
DDL		Piggyback-F	
Select Line A/B to program.			
Select STOP key to Clear.			
Cancel Flush	A	B	Settings/ Vols/CCA

## To program a flush after the Piggyback therapy has started:

1. Press Line B.
2. Press [STOP].
3. Select Line B then follow steps above to program a flush.

When the flush completes, the volume of the delivered flush is subtracted from the Line A VTBI (added to Volume Infused for Line A) and Line A does one of the following:

- If Line A was infusing when the Piggyback delivery started, Line A will resume delivery at its programmed rate.
- If Line A was stopped before the flush started, Line A will return to the stopped state.
- If Line A had a Delayed Start, the Delayed Start countdown will resume from when it was interrupted.
- If Line A was in Standby before the flush started, Line A will return to Standby.

## Cancelling a Flush

---

A flush will automatically be cancelled if one of the following occurs:

- The Line A VTBI is less than the flush volume at the time Line B completes
- Line A has been cleared by the time Line B completes

The infuser will notify you when a flush is automatically cancelled.

The infuser will prompt you to cancel the flush if you try to titrate the current program or enter a new program on Line B while Line A is delivering the flush.

You can manually cancel a flush if Line B is **stopped**.

**To cancel the flush from Line A while the flush is delivering:**

1. Press ▲[Cancel Flush].

A	FLUSH	STOPPED	B
IV Maint Fluid		ceFAZolin	
100	Rate mL/hr	100	
13.3	Vol Inf mL	74.4	
DDL		Piggyback-F	
Select Line A/B to program.			
Select STOP key to Clear.			
Cancel Flush	A	B	Settings/ Vols/CCA

2. Press ▲[Yes] to clear the flush or press ▲[No] to continue the flush.

The Delivery screen displays.

A	Cancel Flush		
Clear Flush?			
Yes: Stop and clear Flush.			
No: Return to previous screen.			
Yes			No

**To cancel the flush from Line B while the Piggyback delivery is stopped:**

1. Press ▲[B].

A	PUMPING	STOPPED	B
IV Maint Fluid		ceFAZolin	
⚠			⚠
100	Rate mL/hr	100	
16.8	Vol Inf mL	74.6	
DDL		Piggyback-F	
Select Line A/B to program. Select STOP key to Clear.			
Standby	A	B	Settings/ Vols/CCA

2. Press ▲[No].

Program			B
Clear Line B Settings?			
Yes: Clear No: Program Screen			
Yes			No

3. Press ▲[Cancel Flush].

Program Piggyback			B
ceFAZolin			
Mode	Piggyback		
Rate	100	mL/hr	⚠
VTBI	9.8	mL	
Duration	00 : 06	hr : min	
DDL			
Enter value using keypad			
Delay	Add Callback	Cancel Flush	Return to A/B



4. Press ▲[Yes] to clear the flush or press ▲[No] to keep the flush programmed.

The Delivery screen displays with Line B stopped.

A	Cancel Flush		
Clear Flush?			
Yes: Stop and clear Flush.			
No: Return to previous screen.			
Yes			No

## Clearing Line Settings

**To clear line settings:**

1. STOP either Line A or Line B to clear. The line must be stopped before clearing settings.
2. Select the line that was stopped (either A or B).
3. The infuser display asks if you want to clear the line settings.

Select ▲[Yes] to clear the line settings.

or,

Select ▲[No] to advance to the program screen for the line selected without clearing the settings.

**NOTE:** Clearing a line does not clear the volumes infused.

## Programming with a Default Drug Library

The default drug library has 113 drugs, including **No Drug Selected**, which is always listed first. After you select a drug, the assigned default dosing unit is highlighted; however, you can change the dosing unit.

## Programming Without a Drug List

### To program without a drug list:

1. On the Delivery (A/B) Screen, select a line to program.

If you are programming a primary delivery, select Line A. If you are programming a secondary delivery, select Line B.



**CAUTION** \_\_\_\_\_  
**BEFORE STARTING DELIVERY, VERIFY THE VALUES.**

2. On the Program screen, enter the rate, VTBI, and duration.  
Values can be entered in any order.

A  on the Confirm Program screen alerts you that the infuser is being operated without rule sets.

## Programming with a Drug List

### To program with a drug list:

1. On the Delivery (A/B) Screen, select a line to program.

If you are programming a primary delivery, select Line A. If you are programming a secondary delivery, select Line B.

2. On the Program screen, select [Drug List].
3. In the drug list, select the drug.
4. Select the dosing unit.
5. Select the drug concentration in container as required for the selected dosing units.

**NOTE:** The remainder of these steps is for a single-step standard program. For information on Bolus Dose, Loading Dose, or Multistep Programming, see [Delivery Options](#) on page 8-1.

6. On the programming screen, enter the concentration, container volume, weight or BSA information as applicable.

See **Body Surface Area (BSA) Dosing Unit** on page 5-1 for information on entering/calculating the BSA.

7. Enter Rate and/or Dose, VTBI, and Duration as appropriate for the displayed program parameters. These values can be entered in any order.



**CAUTION** \_\_\_\_\_  
**BEFORE STARTING DELIVERY, VERIFY THE VALUES.**

8. Press [START].



Confirm the program.

Press ▲[Yes].

## Programming with a Custom Drug Library

### To program with a custom drug library:

1. At power on, select a CCA.

**NOTE:** The CCA can be changed from the Drug List screen. For more information, see **Changing a CCA from the Drug List Screen** on page 5-13.

2. On the Delivery (A/B) Screen, select a line to program. If you are programming a primary delivery, select Line A. If you are programming a secondary delivery, select Line B.
3. In the drug list, select the drug.
4. Select a clinical use. If the selected drug has multiple defined clinical uses, they will be displayed.

5. Select the dosing units. If the selected drug has multiple, defined dosing units, they will be displayed.
6. Select the drug concentration in container units.

If the selected dosing units require a drug concentration in container units, the units will be displayed. In most custom drug library entries, this is already defined and will not require manual selection.

The remainder of these steps are for a single-step standard program. For information on Loading Dose or Multistep Programming, see ***Delivery Options*** on page 8-1.

**NOTE:** For software version 15.20 and later, if a clinical advisory exists in the drug library for the selected medication, the clinical advisory will display before the programming screen. Press the **▲[Continue]** soft key to proceed to the programming screen.

7. On the programming screen, enter the concentration, container volume, weight or BSA information as applicable. See ***Body Surface Area (BSA) Dosing Unit*** on page 5-1 for information on entering/calculating the BSA.
8. Enter the rate and/or dose, VTBI, and duration as appropriate for the displayed program parameters. These values can be entered in any order.



**CAUTION** \_\_\_\_\_  
**BEFORE STARTING DELIVERY, VERIFY THE VALUES.**

---

9. Press [START].



Confirm the program.

Press **▲[Yes]**.

## Hard Limits

If a maximum hard limit is exceeded, an alert appears. You cannot proceed until the entry is cleared.

Press the [C] key to clear the entry and enter a new value.

## Soft Limits

If a soft limit is exceeded, an alert appears when [START] is pressed to confirm the program.

When the alert displays:

- Select ▲[Yes] to override and continue to the confirmation screen.

or,

- Select ▲[No] to return to the program screen and edit the value.

## Changing a CCA from the Drug List Screen

The CCA can be changed from the Drug List screen where it is the first highlighted selection on the screen.

### To change the CCA:

1. On the Drug List screen, highlight ▲[Change CCA] and select ▲[Choose].

The CCA Selection screen displays. The current CCA is indicated by arrows before and after the CCA name.

2. Highlight the desired CCA and select ▲[Choose].

The Drug List screen displays for the chosen CCA.

## Delaying a Line

To program a delayed start, first select a line and program the line (see **Programming** on page 5-1).

1. On the Program screen, press ▲[Delay].
2. Enter time in hours and minutes up to 23:59 hh:mm, and press ▲[Done].
3. Confirm the program.

The Confirmation screen displays the entered delay time.

The delivery screen shows DELAYED and the delay time countdown.

4. To clear a delay, choose the line, press ▲[Delay], then change or clear the delay settings, then press ▲[Done].

## Putting a Line in Standby – A/B Delivery Screen



### **WARNING**

**ENSURE MEDICATIONS THAT ARE DELIVERED CONCURRENTLY, OR IN PIGGYBACK, ARE COMPATIBLE.**

1. On the delivery screen, press ▲[Standby].
2. On the Confirm Standby screen, press ▲[Yes] to put the Piggyback therapy in standby mode and restart the line that is infusing. To return to the Confirm Piggyback screen and program the delivery, press ▲[No].

## Putting a Line in Standby – Confirmation Screen

**To put a line in standby – confirmation screen:**

1. Press ▲[Standby], select the line to put in standby mode.
2. On the Confirm Standby screen, press ▲[Standby].

3. On the Confirm Standby screen, press ▲[Yes] to put the delivery in standby mode and restart the line that is infusing. To return to the Confirm Piggyback screen and program the delivery, press ▲[No].

## Putting a Line in Standby – Piggyback Mode

### To put a line in standby – Piggyback mode:

1. Press ▲[Standby] and confirm by pressing ▲[Yes]. Line B will stand by, line A will remain pending.
2. Press ▲[Restart A] to restart line A.

## Canceling Standby – Piggyback Mode

### To cancel standby – Piggyback mode:

1. On the delivery screen, select the line that is in standby.
2. On the Cancel Standby screen, press ▲[Yes] to resume infusion. To keep the line in standby mode, press ▲[No].

## Nurse Callback

To add a nurse callback on programming screen, press ▲[Add Callback].

Callback is available for Piggyback, Loading Dose, Multistep, and Bolus deliveries.

---

---

# Notes

---

---



---

## Section 6

# Auto-Programming

---

Auto-programming is the ability to take an I.V. medication order from the Bar Code Medication Administration (BCMA) system and translate it into operational settings that can automatically populate the infuser. Order taking is done by using the BCMA application and its bar code scanner to scan the patient identification, the medication container, and the infuser. Scanned information is transferred to the infuser via either its wireless antenna or RJ-45 Ethernet connector with a shielded Ethernet cable.

**NOTE:** The wireless icon  does not appear when an Ethernet cable is used to connect the infuser to the BCMA system.

The integration of ICU Medical MedNet software with a BCMA system enables the system to incorporate pharmacy-validated orders into the Five Rights verification process reducing the number of steps to manually program the infuser.

After verifying that the order is within the allowed parameters, ICU Medical MedNet software sends the program parameters to the infuser. A clinician has the option of manually editing the program or confirming and starting the infusion.

Auto-programming can only be used if this feature has been licensed and in conjunction with the BCMA system.

# Auto-Programming the Plum 360 Infuser

Before you begin auto-programming, make sure that a cassette is installed in the infuser. To perform auto-programming:

1. Press [ON/OFF]. The infuser begins its startup process. After two minutes, the infuser is ready to accept an auto-programming request.

The delivery screen appears.

2. Choose a CCA.

To see the chosen CCA, press ▲[Change CCA]. The chosen CCA is indicated by arrows before and after the CCA name.

A		B
0	Rate mL/hr	0
0	Vol Inf mL	0
Medical ICU1		
Select Line A/B to program		
Back Prime	A	B
		Settings / Vols / CCA

3. Follow your hospital's procedure to activate your BCMA device.
4. Scan the patient wristband to retrieve the patient's task list on the device.
5. Scan the medication. The I.V. task and documentation with order details are displayed on the device.
6. Scan the barcode on the infuser.

**NOTE:** If the scanned medication does not exist in the drug library, no medication will be displayed on the infuser and "No Drug Selected" will be shown on the subsequent Confirmation and Main Delivery Screens.

The programming screen is automatically filled.

- Verify ALL parameters. If changes are desired, you can manually change the infusion parameters using the keypad on the infuser.



Before starting delivery, press [START], then confirm the program.

A	Program		
<b>DOPamine(CARDIAC)</b>			
Conc	400 mg	250 mL	
Weight	60 kg		
Dose	10	mcg/kg/min	
Rate	22.5	mL/hr	
VTBI	250	mL	
Duration	11 : 06	hr : min	
<b>Medical ICU1</b>			
Enter value using keypad			
Delay			Return to A/B

- When all values are completed, press [START] to confirm the program with the received order.
- Select ▲[Yes] to start delivery or ▲[No] to edit the program.

The BCMA will confirm the program with the original order.

- Complete the transaction on the BCMA unit or document the process per hospital procedure.

A	Confirm Program		
<b>DOPamine(CARDIAC)</b>			
Conc	400 mg	250 mL	
Weight	60 kg		
Dose	10	mcg/kg/min	
Rate	22.5	mL/hr	
VTBI	250	mL	
Duration	11 : 06	hr : min	
<b>Medical ICU1</b>			
Yes: Start delivery			
No: Edit			
Yes	Standby		No

If your order is rejected, refer to [Rejected Auto-Programs](#) on page 9-25.

**NOTE:** For software version 15.11 and later, when an auto-program is confirmed for a new bag, the infuser will clear the volume infused value displayed on the delivery screen.

---

---

# Notes

---

---

---

## Section 7

# Additional Features

---

## Delay a Line

To program a delayed start, first select a line and program the line (see [Programming](#) on page 5-1).

1. On the Program screen, press ▲[Delay].
2. Enter time in hours and minutes up to 23:59 hh:mm, and press ▲[Done].
3. Confirm the program.

The Confirmation screen displays the entered delay time.

The delivery screen shows DELAYED and the delay time countdown.

4. To clear a delay, choose the line, press ▲[Delay], then change or clear the delay settings, then press ▲[Done].

## Standby

Standby is a feature that enables you to postpone starting delivery for a period of 24 hours to 72 hours. The default setting is 72 hours. The maximum standby time is configured by the Biomed if the infuser is using the Default Drug Library. It is defined in the Custom Drug Library per CCA if one is installed on the infuser. You can leave the infuser in standby up to the configured maximum.

A line must be infusing to be put in Standby.

If a line is in standby and the configured maximum standby time expires, the program on the line is cleared and the infuser alarms 2 minutes later when there has been no interaction with the infuser on either line.

The instructions below describe how to put one or both lines in Standby from the Delivery screen. This can also be accomplished for a single line from that line's Confirmation screen.

## Put 1 or 2 Lines in Standby from the Delivery Screen (Non-Piggyback)

1. On the Delivery screen, press ▲[Standby].

If both lines are PUMPING, the infuser will give you the option to select a line, select both lines, or cancel the request.

2. If the option is provided to standby a line or both lines, select the appropriate softkey.

The Confirm Standby screen displays.

3. On the Confirm Standby screen:

- Press ▲[Yes] to confirm the requested standby selection.
- Press ▲[No] to cancel the standby request and return to the Delivery (A/B) screen.

## Cancel Standby for 1 or 2 Lines from the Delivery Screen (Non-Piggyback)

1. Press [START].

The Cancel Standby screen displays. If both lines are in standby, the infuser will give you the option to select a line, select both lines, or cancel the request. If only one line is in standby, the infuser will give you the option to cancel standby for the line or cancel the request to cancel standby.

2. Select the appropriate softkey.

Delivery resumes on the selected line(s).

**NOTE:** A or B softkeys can be used to remove just one line from standby. Even if both lines are in standby, this method of canceling standby will only affect the line you selected the softkey for.

## Put Piggyback Mode in Standby



**WARNING** \_\_\_\_\_  
**ENSURE MEDICATIONS THAT ARE DELIVERED  
CONCURRENTLY, OR IN PIGGYBACK, ARE COMPATIBLE.**

---

1. While Line B is PUMPING and Line A is PENDING, press ▲[Standby].
2. On the Confirm Piggyback Therapy Standby screen:
  - Press ▲[Yes] to confirm the standby request. This will place Line B in standby and leave Line A in PENDING.
  - Press ▲[Restart A] to confirm the standby request. This will place Line B in standby and place Line A in PUMPING.
  - Press ▲[No] to cancel the standby request and return to the Delivery (A/B) screen.

## Cancel Piggyback Mode Standby

1. Press [START] or ▲[B].
2. On the Cancel Piggyback Therapy Standby screen:
  - Press ▲[Yes] to confirm the cancel standby request. This will return to the Piggyback therapy with Line A PENDING and Line B PUMPING.
  - Press ▲[No] to cancel the cancel standby request and return to the Delivery (A/B) screen leaving both lines in their current states.

# Examples of Automatic Calculation

## mL/hr - Initial Programming

Initial programming allows the clinician to enter two of the three programming parameters (Rate, VTBI, or Duration) and the third is automatically calculated. (*Refer to the table below*)

1st Action	2nd Action	[AUTOCALC]
enter RATE	enter VTBI	[DURATION]
enter VTBI	enter DURATION	[RATE]
enter RATE	enter DURATION	[VTBI]

## mL/hr - After VTBI Complete Alarm

1st Action	2nd Action	[AUTOCALC]
enter VTBI	keep RATE	[DURATION]
enter VTBI	change DURATION	[RATE]
enter DURATION	keep RATE	[VTBI]
enter DURATION	change VTBI	[RATE]
change RATE	enter VTBI	[DURATION]
change RATE	enter DURATION	[VTBI]



## Non-Time-Based Dose Calculation (for example, mL) - Initial Programming

1st Action	[AUTOCALC]	2nd Action	[AUTOCALC]
enter DOSE	[VTBI]	enter DURATION	[RATE]
enter DOSE	[VTBI]	enter RATE	[DURATION]
enter VTBI	[DOSE]	enter DURATION	[RATE]
enter VTBI	[DOSE]	enter RATE	[DURATION]
enter DURATION	N/A	enter DOSE	[RATE], [VTBI]
enter DURATION	N/A	enter RATE	[DOSE], [VTBI]
enter DURATION	N/A	enter VTBI	[RATE], [DOSE]
enter RATE	N/A	enter DOSE	[DURATION], [VTBI]
enter RATE	N/A	enter DURATION	[DOSE], [VTBI]
enter RATE	N/A	enter VTBI	[DURATION], [DOSE]

## Non-Time-Based Dose Calculation (for example, mL) - After VTBI Complete Alarm

With the exception of the entry of the VTBI auto-calculating the Dose and the entry of the Dose auto-calculating the VTBI, all auto-calculation for a non-time-based program is the same as auto-calculation for an mL/hr program after a VTBI Complete alarm.

## Time-Based Dose Calculation (for example, mg/min) - Initial Programming

1st Action	[AUTOCALC]	2nd Action	[AUTOCALC]
enter DOSE	[RATE]	enter DURATION	[VTBI]
enter DOSE	[RATE]	enter VTBI	[DURATION]
enter RATE	[DOSE]	enter DURATION	[VTBI]
enter RATE	[DOSE]	enter VTBI	[DURATION]
enter VTBI	N/A	enter DOSE	[RATE], [DURATION]
enter VTBI	N/A	enter RATE	[DOSE], [DURATION]
enter DURATION	N/A	enter DOSE	[RATE], [VTBI]
enter DURATION	N/A	enter RATE	[DOSE], [VTBI]
enter DURATION	N/A	enter VTBI	[RATE], [DOSE]

Once the VTBI is > 0, then the Duration cannot be changed, even during initial programming. This prevents the Dose/Rate from being calculated or recalculated when the Duration is changed.

**NOTE:** If DURATION is entered first and a VTBI < 1 mL is entered second, the DURATION value will be reset to 0 and either RATE or DOSE will need to be entered.

## Time-Based Dose Calculation (for example, mg/min) - After VTBI Complete Alarm

1st Action	[AUTOCALC]	2nd Action	[AUTOCALC]
enter DURATION (if VTBI = 0)*	[VTBI]	keep DOSE	keep RATE
enter VTBI	[DURATION]	keep DOSE	keep RATE
enter DURATION (if VTBI = 0)*	[VTBI]	keep RATE	keep DOSE
enter VTBI	[DURATION]	keep RATE	keep DOSE

\*If VTBI is > 0, then the Duration cannot be changed.

Any changes except those listed in the above table will follow the auto-calculation rules in the *Time-Based Dose Calculation (for example, mg/min) - Initial Programming* on page 7-6.

## Recalculation Alert When Titrating a Confirmed mL/hr or Non-Time-Based Dosing Unit

If you change the Duration of a confirmed mL/hr or non-time-based dosing unit program and press [START] to confirm the titration, a Recalculation Alert will be displayed indicating that the rate has been recalculated due to the duration change.

Press ▲[Yes] to continue to the Confirmation screen.

Press ▲[No] to return to the programming screen.

The Recalculation Alert will not occur for initial programming or programming after a VTBI Complete alarm.

---

---

# Notes

---

---

---

## Section 8

# Delivery Options

---

## Programming a Bolus Dose

**NOTE:** Bolus dose functionality is available in software version 15.1 and later.

A Bolus delivery is defined as a rapid infusion of a relatively large volume of fluid or dose of the drug currently being administered (same medication, concentration, and dosing unit) to magnify a therapeutic response. A stand-alone bolus dose of a new medication cannot be delivered.

Bolus can be delivered from either line A or line B (while in the piggyback mode). Bolus delivery is available only when using a Custom Drug Library with the ICU Medical MedNet application; it is not available in the Default Drug Library. Those medications which can be delivered by bolus will have dose, time, and bolus limits defined in the drug library.

A Bolus can be completed only if the following conditions are present:

- the line on which the bolus is to be delivered is currently infusing,
- Bolus Dose is enabled within the medication's selected profile,
- Rule Sets permit the medication to be delivered by bolus,
- there is adequate VTBI of the medication to complete the bolus dose, and
- the device is in Piggyback mode (not Concurrent mode) if the bolus is to be delivered on Line B (see [Changing the Default Line B Delivery Mode](#) on page 3-39).

**To program a bolus on Line A:**

1. Press ▲[A] (the Line A softkey).
2. Press ▲[Bolus] (the Bolus softkey is available only if the medication to be bolused is enabled in the drug library and is currently infusing).
3. On the Bolus programming screen, enter the dose and duration, rate and VTBI will be calculated.

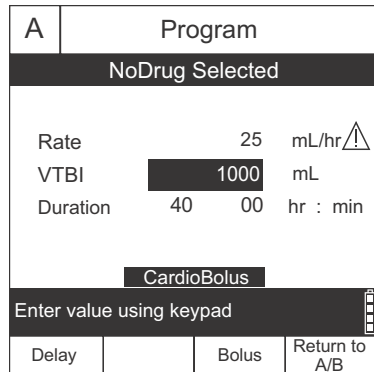

4. Optional: To add a Callback alarm when the Bolus delivery completes, press ▲[Add Callback]. When the Callback alarm occurs, it must be manually cleared. If a Callback alarm is configured on and you want to remove it; press ▲[Remove Callback].
5. Press [START] for confirmation.
6. Select ▲[Yes] to start delivery or ▲[No] to edit parameters.

**NOTE:** The Status Region will show BOLUS on Line A. Upon completion, the infuser will resume the continuous infusion which was previously infusing and the nurse callback alarm will activate if programmed.

**To program a bolus on Line B:**

**NOTE:** Bolus is available on Line B only when in Piggyback mode (see [Changing the Default Line B Delivery Mode](#) on page 3-39) and when the medication to be bolused is enabled in the drug library and is currently infusing.

1. Press ▲[B] (the Line B softkey).
2. Press ▲[Bolus],

3. On the Bolus programming screen, enter the dose and duration, rate and VTBI will be calculated.
4. Optional: To add a Callback alarm when the Bolus delivery completes, press ▲[Add Callback]. When the Callback alarm occurs, it must be manually cleared. If a Callback alarm is configured on and you want to remove it; press ▲[Remove Callback].
5. Press [START] for button for confirmation.
6. Select ▲[Yes] to start delivery or ▲[No] to edit parameters.

**NOTE:** The Status Region will show BOLUS on Line B. Upon completion, the infuser will resume the piggyback which was previously infusing and the nurse callback alarm will activate if programmed. If Line A was previously in a PENDING state, it will remain in PENDING until the bolus and the underlying piggyback are complete.

### To stop or cancel a bolus:

1. To stop a bolus during infusion, press [STOP].

**NOTE:** After the bolus is stopped, selecting the channel the bolus was infusing will display the softkeys ▲[Cancel Bolus], ▲[Add Callback], ▲[Resume Bolus], or ▲[Return to A/B].

2. To cancel a bolus during infusion, press ▲[Cancel Bolus].

**NOTE:** The following will appear in the working region of the screen: Clear Line Bolus Settings? Yes to stop and Clear Bolus, No to return to previous screen.

## Programming a Loading Dose

A Loading Dose delivery is a sequential program that can deliver up to 2 doses (Loading Dose and Maintenance Dose) from one container at different rate/dose/VTBI and durations using the same dosing unit.

A Loading Dose delivery is a two-step process that delivers an initial dose of a medication fluids followed by a maintenance dose of the same medication fluids.

Both steps must be programmed with the same dosing unit (mL/hr or mg/kg/min, for example) and drug concentration. You can change the dosage either by entering a different dose (the infuser calculates the rate needed to deliver that dose) or by entering a new rate directly.

The following procedure describes how to program a Loading Dose delivery. As an example, 4 mcg/mL solution of Dexmedetomidine is delivered in a Loading Dose of 1 mcg/kg/hr for 10 minutes, followed by a maintenance dose of 0.2 mcg/kg/hr for 2 hours.

**NOTE:** All drugs and associated dosages shown in this manual are used solely for the purpose of demonstrating how to program the Plum 360 infuser, and are not meant to represent actual clinical practice.



**To program a Loading Dose delivery:**

Start programming the line as defined in *Programming* on page 5-1 until you reach the step that directs you to this section for a Loading Dose program.

1. Press ▲[Loading Dose] before entering any values on the programming screen.

**NOTE:** If you do not see ▲[Loading Dose] in the softkey row, press ▲[Return to A/B] to start over again.

The Program Loading Dose screen appears.

2. On the programming screen, enter the concentration, container volume, weight or BSA information as applicable. See *Body Surface Area (BSA) Dosing Unit* on page 5-1 for information on entering/calculating the BSA.

**NOTE:** On the Program Loading Dose screen, 1 represents the Loading Dose and 2 represents the Maintenance Dose.

3. Enter Rate and/or Dose, VTBI, and Duration as appropriate for the parameters displayed for 1 (Loading Dose). Navigate between entry fields. See *Auto-Calculations* on page 5-1 for additional information on auto-calculations performed by the infuser.
  4. After completely programming 1 (Loading Dose), navigate to 2 (Maintenance Dose) and program the maintenance dose parameters.
  5. Optional: To add a Callback alarm when the Loading Dose VTBI completes, press ▲[Add Callback]. When the Callback alarm occurs, it must be manually cleared. If a Callback alarm is configured on and you want to remove it, press ▲[Remove Callback].
- NOTE:** The infuser will issue a VTBI Complete alarm after the Maintenance Dose VTBI is delivered.
6. When both 1 (loading dose) and 2 (maintenance dose) are programmed, press [START]. The Confirm Loading Dose screen appears.

7. Confirm that all programming is correct, and then press ▲[Yes] to start delivery of 1 (loading dose).

The delivery screen displays the drug name (or No Drug Selected, if applicable), the dosing units, what is currently being delivered (Loading Dose or Maintenance), the dose (if applicable), rate, and current volume infused for the delivery, and if Callback is configured on.

When 2 (Maintenance Dose) is complete, the infuser issues a VTBI Complete alarm and begins delivering the Post Infusion Rate, unless delivering in Piggyback mode.

## Programming a Multistep Delivery

Multistep delivery is a sequential program that can deliver up to 10 steps from one container at different rate/dose/VTBI and durations using the same dosing unit and concentration.

### To program a Multistep delivery:

1. Press ▲[Multistep] before entering any values on the programming screen.

**NOTE:** If you do not see ▲[Multistep] in the softkey row, press ▲[Return to A/B] to start over again.

The Program Multistep screen appears.

2. On the programming screen, enter the concentration, container volume, weight or BSA information as applicable. See **Body Surface Area (BSA) Dosing Unit** on page 5-1 for information on entering/calculating the BSA.

**NOTE:** On the Program Multistep screen, 1 represents Step 1, 2 represents Step 2, etc.

3. Enter Rate and/or Dose, VTBI, and Duration as appropriate for the parameters displayed for Step 1. Navigate between entry fields. See **Auto-Calculations** on page 5-1 for additional information on auto-calculations performed by the infuser.

4. After programming all values in 1 (Step 1), navigate to the 2 (Step 2), and program that step.
5. After programming all values in 2 (Step 2), continue with 3 (Step 3) if desired.

As soon as all values in Step 3 are populated, ▲[To Steps 4-10] appears in the softkey row.

6. Press ▲[To Steps 4-10] to program additional steps, if needed.
7. Optional: To add a Callback alarm when each step, except the last step, completes, press ▲[Add Callback]. When the Callback alarm occurs, it must be manually cleared. If a Callback alarm is configured on and you want to remove it, press ▲[Remove Callback].

**NOTE:** The infuser will issue a VTBI Complete alarm after the last step.

8. When all steps are programmed, press [START]. The Confirm Multistep screen appears.

If no more than 3 steps are programmed, the Confirm Multistep screen prompts you to start the delivery.

Otherwise, if more than 3 steps are programmed, confirm that the programming for the first 3 steps is correct and then press ▲[To Steps 4-10]. The confirmation screen displays for the additional steps and prompts you to start the delivery.

9. Confirm that all programming is correct, and then press ▲[Yes] to start the delivery for 1 (Step 1).

The delivery screen displays the drug name (or No Drug Selected, if applicable), the dosing units, the step that is currently being delivered out of how many steps that have been programmed (for example, Step 1 of 4), and the information for the step that is delivering.

When the last step is complete, the infuser issues a VTBI Complete alarm and begins delivering the Post Infusion Rate, unless delivering in Piggyback mode.

## Adding a Step to a Multistep Delivery

A step can be added to a running Multistep infusion only after a running step or a step that has not yet started delivery.

**NOTE:** If the infusion is stopped, the softkey used to add a new step changes to add or remove the Callback.

### To add a step to a running Multistep infusion:

1. Select the line.
2. Select ▲[Add New Step].
3. Enter the number of the step after which you want to add a new step.
4. Select ▲[Add Step].
5. Enter the Dose, Rate, VTBI, or Duration for the step as desired.
6. Press [START] and confirm the program as described in *Programming a Multistep Delivery* on page 8-6.

# Adding VTBI to Loading Dose or Multistep Program After VTBI Complete Alarm Activates

The status of delivery steps is shown on the Program screens for Line A and Line B.

Display Indicator	Delivery Step Status
*	Step is currently running.
d	VTBI for step has completed.
Number	Infusion for step not started yet OR VTBI is complete and VTBI can be added to the step as described below.

**NOTE:** When the last step has completed delivery and the post-infusion rate has begun delivery, the last step display indicator returns to the step number.

During a Loading Dose delivery or a Multistep delivery, after the VTBI Complete alarm activates and post-infusion rate delivery has begun, as long as the post-delivery rate infusion has not been stopped you can add more VTBI to the last delivery step, if needed.

If you stop infusion after VTBI has completed, you can add more VTBI, but you must add it to *all* delivery steps before restarting the program.

**To add more VTBI to the last step (Multistep) or maintenance dose (Loading Dose) while post-infusion rate delivery continues:**

1. Select the line.
2. Navigate to the VTBI for the last step. Step display indicators will have returned to the step number, indicating it is editable.
3. Enter a VTBI.

4. Press [START] and confirm the program as described in ***Programming a Loading Dose*** on page 8-4 and ***Programming a Multistep Delivery*** on page 8-6.

**To stop the post-infusion rate and add more VTBI to all steps:**

1. Stop the line running the program to which you want to add more VTBI.

**NOTE:** When adding VTBI, you can also update other step parameters if necessary.

2. Reselect the line.
3. In the Program screen, press ▲[No] to edit the program. All step display indicators will have returned to numbers, indicating they are editable.
4. Enter the VTBI.

**NOTE:** You must add VTBI to all steps.

5. Press [START] and confirm the program as described in ***Programming a Loading Dose*** on page 8-4 and ***Programming a Multistep Delivery*** on page 8-6.

# Titration

Titration is a change in Dose/Rate, Duration, and/or VTBI in a currently running or programmed infusion.

**NOTE:** Titration cannot be performed while a bolus dose is being delivered.

## Loading Dose Delivery and Multistep Delivery

In a Loading Dose delivery or Multistep delivery, during infusion and before VTBI is completed, titration can be performed only on steps where the display indicator is an \* or a number.

### To perform titration:

1. Select the line to titrate.
2. Navigate to any step where the display indicator is an \* or a number and change the Dose, Rate, VTBI, or Duration for the step as desired.
3. Press [START] and confirm the program as described in [Programming a Loading Dose](#) on page 8-4 and [Programming a Multistep Delivery](#) on page 8-6.

## Changing the CCA During Infusion

### To change the CCA during infusion:

1. Press ▲[Settings/Vols/CCA].
2. Press ▲[Change CCA]. The current CCA is indicated by arrows before and after the CCA name.
3. Choose a CCA.

When the Delivery screen displays, the infuser will inform the user that line is delivering under a prior CCA. Until a VTBI Complete alarm occurs for the line, you can still titrate the infusion on that line under the old CCA.

**When a VTBI Complete alarm occurs on a line that is infusing under a prior CCA:**

1. Stop the line.
2. Clear the volume for the line, if desired.
3. Select the line.
4. Clear the line settings.
5. Reprogram the line under the current CCA.



---

## Section 9

# Alarms and Troubleshooting

---

## Alarm Priority Levels

The Plum 360 infuser has an intelligent alarm system that handles more than one alarm at a time. Alarms are prioritized as high, medium, or low. You can distinguish the priority by the number of beeps:

Priority	Number of Beeps
High	10
Medium	3
Low	2

The alarm sound pressure range is from 45 dB to 70 dB, depending on the setting of the alarm loudness control located on the back of the infuser.

The alarm sound pressure is measured in accordance with IEC 60601-1-8:2012.



---

**WARNING**

**SETTING THE ALARM SOUND PRESSURE LEVEL LOWER THAN THE AMBIENT SOUND PRESSURE LEVEL CAN IMPEDE OPERATOR RECOGNITION OF ALARM CONDITIONS.**

---

# General Alarms

## High Priority Alarms

Alarm Message and Priority	Possible Cause	Corrective Action
Power Off then On. Replace pump if alarm continues. <b>High</b> <b>Various E### Alarms</b>	Malfunction.	Power the infuser off, and then on. Replace infuser if this does not clear the alarm.
Replace pump. Audio alarm failure. <b>High</b> <b>E301</b>	Audio alarm is OFF but sensed ON, or ON but sensed OFF.	Power off the infuser.
Replace pump. Backlight failure. <b>High</b> <b>E302</b>	Backlight voltage out of range during operation.	Power off the infuser.
Line B VTBI complete in prior CCA! Press STOP key. <b>High</b> <b>N160</b>	Line B delivery is complete, the line was programmed under a different CCA than the CCA currently being used, and Line B has a Concurrent delivery programmed.	Stop the delivery on Line B or open the cassette door.

Alarm Message and Priority	Possible Cause	Corrective Action
Distal OCCLUSION! Resolve then Backprime. <b>High</b> <b>N180</b>	Distal occlusion detected while attempting to backprime or during cassette check.	Examine the distal line for kinks. Resolve the distal occlusion and then either backprime or open and close the cassette door.
Distal OCCLUSION! Check IV line and site. <b>High</b> <b>N186</b>	A distal occlusion is detected and either the maximum auto- restarts have occurred for the infusion or auto- restart was set to zero.  OR  An N192 alarm has been active for 60 seconds without the pressure dropping below the distal occlusion pressure threshold.	Examine the distal line for kinks and correct any found. Restart the delivery. <b>Note:</b> (software versions 15.11 and earlier) The alarm can also be cleared by clearing the confirmed programs on any programmed line or opening the cassette door.  <b>Note:</b> (software versions 15.20 and later) The alarm can also be cleared by pressing the [A] or [B] softkey for any programmed line or opening the cassette door.  See <i>Avoiding            Unintended Bolus            While Resolving a            Distal Occlusion</i> on page 4-31.
<div style="border: 1px solid red; padding: 5px;"> <p><b>WARNING</b></p> <div style="display: flex; align-items: center;">  <p style="color: red; font-weight: bold; margin: 0;">THE PLUM 360 INFUSER DOES NOT HAVE CAPABILITY TO DETECT INFILTRATION TO THE PATIENT</p> </div> </div>		

<b>Alarm Message and Priority</b>	<b>Possible Cause</b>	<b>Corrective Action</b>
<p>Pump too high above patient. Lower Pump or replace set. <b>High</b> <b>N187</b></p>	<p>Distal occlusion detected during delivery due to too much backpressure.</p>	<p>Resolve the occlusion by lowering the infuser on the pole to place it closer to the level of the patient's heart (see <a href="#">Delivery Accuracy</a> on page 11-10) and then press [START].  <b>Note:</b> The alarm can also be cleared by clearing the confirmed programs on any programmed line or opening the cassette door.</p>
<p>Data was cleared. Re-enter all programming <b>High</b> <b>N103</b></p>	<p>Corruption of retained delivery parameters is detected. Autoclear of SEEP requires fresh delivery setup.</p>	<p>Acknowledge the alarm.</p>
<p>Distal AIR! Disconnect / reprime. Press START. <b>High</b> <b>N233 / N234</b></p>	<p>The single air bolus or the cumulative air detected at the distal sensor exceeds the air detection threshold.</p>	<p>Open the cassette door. See <a href="#">Resolving a Distal Air-in-Line Alarm</a> on page 4-30.</p>
<p>Door opened! Infusion stopped! Close Door. <b>High</b> <b>N250</b></p>	<p>The cassette door was opened during a delivery.</p>	<p>Close the cassette door with the cassette inserted.</p>

<b>Alarm Message and Priority</b>	<b>Possible Cause</b>	<b>Corrective Action</b>
Cassette test failure! Check set. <b>High</b> <b>N251</b>	Faulty cassette, proximal occlusion, or air was detected in the cassette during the cassette test.	Resolve occlusion and then open and close the cassette door. Press ▲[Back Prime]. Replace administration set.
Depleted Battery! Plug into AC now! <b>High</b> <b>N252</b>	The infuser is running on battery power and the battery voltage is below the depleted battery threshold.	Plug into an AC (mains) power source.
Keypad locked. Enter code to disable. <b>High</b> <b>N255</b>	While the keypad was locked, someone pressed [STOP] or opened the cassette door during delivery.	Enter valid keypad unlock code.

## Medium Priority Alarms

Alarm Message and Priority	Possible Cause	Corrective Action
Door opened! Delayed Start! Close Door <b>Medium</b> <b>N108</b>	The cassette door was opened while an infusion was in Delayed Start.	Close the cassette door with cassette inserted.
Distal OCCLUSION - Paused! Attempting restart. <b>Medium</b> <b>N192</b>	A distal occlusion was detected, auto-reset is configured on, and the maximum number of auto-resets have not occurred for the infusion.	Examine the distal line for kinks and correct any found. No action is necessary if the patient can resolve the alarm condition within 60 seconds of activation (for example, moving an arm to eliminate the occlusion) before the maximum retry number is reached. Open the cassette door.

## Low Priority Alarms

<b>Alarm Message and Priority</b>	<b>Possible Cause</b>	<b>Corrective Action</b>
Keep Plugged into AC! Service battery / replace pump. <b>Low</b> <b>N56 / N57</b>	The battery or battery charge circuitry needs servicing.	Power off the infuser. Replace the infuser as soon as possible, so that it can be sent for repair.
Power Off then On. Replace pump if alarm continues. <b>Low</b> <b>E325</b>	Battery voltage is greater than the expected limit.	Power off the infuser.
Low Battery! Plug into AC power! <b>Low</b> <b>N58</b>	The battery charge level is low.	Plug into AC (mains) power.

Alarm Message and Priority	Possible Cause	Corrective Action
<p>Programming not complete! Action required!</p> <p><b>Low</b> <b>N102</b></p>	<p>(software version 15.1 and earlier) No operator input for 2 minutes after the infuser is powered on in Clinical mode, except for situations that trigger an <b>N101</b>.</p> <p>(software version 15.11 and later) No operator input for 2 minutes after the infuser is powered on in Clinical mode, with a cassette installed or a confirmed program, except for situations that trigger an <b>N101</b>.</p>	<p>Press any hardkey or softkey except the [AUDIO PAUSED] hardkey.</p>



# Line A Alarms

## High Priority Alarms

Alarm Message and Priority	Possible Cause	Corrective Action
<p>No Action Alarm! Start or Clear line A.</p> <p><b>High</b> <b>N101</b></p>	<p>(software versions 15.11 and earlier)</p> <p>No operator action for 2 minutes when Line A has been stopped by the user and is not cleared or restarted.</p> <p>(software versions 15.20 and later)</p> <p>No operator action for 2 minutes when Line B is not programmed, and Line A has been stopped by the user and is not cleared or restarted.</p> <p><b>Note:</b> Will reassert if the condition persists.</p>	<p>Press any hardkey on the infuser except [AUDIO PAUSED]. Select Line A to program or clear it.</p>
<p>Line A VTBI complete in prior CCA! Press STOP key.</p> <p><b>High</b> <b>N161</b></p>	<p>Line A was programmed under a different CCA than is currently being used and delivery is complete.</p>	<p>Stop the delivery on Line A. Open the cassette door.</p>

Alarm Message and Priority	Possible Cause	Corrective Action
<p>VTBI Completed Line A! Add more VTBI or Clear A.</p> <p><b>High</b> <b>N161</b></p>	<p>Line A delivery is complete and line was programmed under the CCA that is currently being used.</p>	<p>Add VTBI on Line A. Stop Line A. Open the cassette door.</p>
<p>Proximal OCCLUSION A! Check Line A.</p> <p><b>High</b> <b>N190 / N191</b></p>	<p>Proximal occlusion or air detected on Line A during delivery.</p>	<p>Examine the proximal line for kinks and correct any found. If the occlusion is caused by a closed clamp, open the clamp. If all clamps are open, the alarm may be caused by excessive air that is creating backpressure in the cassette.</p> <p>To remove the air, see <b>Backpriming</b> on page 4-21.</p> <p>Check the syringe size. See <b>Administration Sets and Accessories Guidelines</b> on page 1-19.</p> <p>Restart Line A.</p> <p><b>Note:</b> The alarm can also be cleared by clearing the confirmed programs on any programmed line or opening the cassette door.</p>

Alarm Message and Priority	Possible Cause	Corrective Action
Proximal AIR Line A! Backprime. <b>High</b> <b>N232</b>	The single air bolus detected at the proximal sensor in Line A exceeds the air detection threshold.	Press ▲[Back Prime]. See <a href="#">Backpriming</a> on page 4-21. Check the syringe size. See <a href="#">Administration Sets and Accessories Guidelines</a> on page 1-19.

## Medium Priority Alarms

Alarm Message and Priority	Possible Cause	Corrective Action
Callback to Line A! Silence audio to clear. <b>Medium</b> <b>N105</b>	A Callback Alarm was programmed for Line A, and the VTBI for Line A reaches 0 for a Loading Dose or any step in a multistep therapy except the last step.	Press [AUDIO PAUSED].

Alarm Message and Priority	Possible Cause	Corrective Action
<p>Proximal OCCLUSION A! Resolve then Backprime. <b>Medium</b> <b>N184</b></p>	<p>Proximal occlusion detected on Line A during backprime.</p>	<p>Examine Line A for kinks. Resolve the occlusion. Either backprime or open and close the cassette door. Check the syringe size. See <b>Administration Sets and Accessories Guidelines</b> on page 1-19.</p>
<p>Bolus complete on Line A! Silence audio to clear. <b>Medium</b> <b>N107</b> (software version 15.1 and later)</p>	<p>Bolus delivery completes on Line A and a Nurse Callback was configured.</p>	<p>Press [AUDIO PAUSED].</p>
<p>Prox OCCLUSION A Startup! Open/close door or Backprime. <b>Medium</b> <b>N185</b></p>	<p>A proximal occlusion was detected on Line A during the cassette integrity test.</p>	<p>Examine Line A for kinks. Resolve the occlusion. Either backprime or open and close the cassette door. See <b>Opening the Cassette Door Completely</b> on page 3-7. Check the syringe size. See <b>Administration Sets and Accessories Guidelines</b> on page 1-19.</p>

# Line B Alarms

## High Priority Alarms

Alarm Message and Priority	Possible Cause	Corrective Action
<p>No Action Alarm! Start or Clear line B.</p> <p><b>High</b> <b>N101</b></p>	<p>(software versions 15.11 and earlier)</p> <p>No operator action for 2 minutes when Line B has been stopped by the user and is not cleared or restarted.</p> <p>(software versions 15.20 and later)</p> <p>No operator action for 2 minutes when Line A is not programmed, and Line B has been stopped by the user and is not cleared or restarted.</p> <p><b>Note:</b> Will reassert if the condition persists.</p>	<p>Press any hardkey on the infuser except [AUDIO PAUSED]. Select Line B to program or clear it.</p>
<p>Line B VTBI complete in prior CCA! Clear line B.</p> <p><b>High</b> <b>N160</b></p>	<p>A Line B Piggyback delivery that was programmed under a different CCA is complete, and no delivery is programmed on Line A.</p>	<p>Clear the program on Line B. Open the cassette door.</p>

<b>Alarm Message and Priority</b>	<b>Possible Cause</b>	<b>Corrective Action</b>
VTBI Completed Line B! Add more VTBI or Clear B.  <b>High</b> <b>N160</b>	A Piggyback delivery on Line B is complete and the line was programmed under the current CCA and no delivery is programmed to deliver on Line A.  <b>Note:</b> Piggyback with a Line A delivery will not alarm; it will just transition to Line A delivery.	Add VTBI on Line B. Clear program on Line B. Open the cassette door.
VTBI Completed Line B! Add more VTBI or Clear B.  <b>High</b> <b>N160</b>	A Concurrent delivery on Line B is complete and the line was programmed under the current CCA.	Add VTBI on Line B. Stop the delivery on Line B. Open the cassette door.

Alarm Message and Priority	Possible Cause	Corrective Action
<p>Proximal OCCLUSION B! Resolve then Backprime. <b>High</b> <b>N183</b></p>	<p>Proximal occlusion detected on Line B during cassette integrity test.</p>	<p>Examine line B for kinks. Make sure a line or syringe is attached to the secondary port and that the line is unclamped or the syringe has enough free space to accept the backprimed fluid. Either backprime or open and close the cassette door. See <b>Backpriming</b> on page 4-21 to remove the air. Check the syringe size. See <b>Administration Sets and Accessories Guidelines</b> on page 1-19.</p>
<p>Proximal OCCLUSION B! Check Line B. <b>High</b> <b>N188 / N189</b></p>	<p>Proximal occlusion detected on Line B during delivery.</p>	<p>Examine the proximal line for kinks and correct any found, Restart Line B. <b>Note:</b> The alarm can also be cleared by clearing the confirmed program or opening the cassette door.</p>

Alarm Message and Priority	Possible Cause	Corrective Action
<p>Proximal AIR Line B! Backprime. <b>High</b> <b>N231</b></p>	<p>The single air bolus detected at the proximal sensor in Line B exceeds the air detection threshold.</p>	<p>Press ▲[Back Prime]. See <b>Backpriming</b> on page 4-21. Check the syringe size. See <b>Administration Sets and Accessories Guidelines</b> on page 1-19.</p>



## Medium Priority Alarms

Alarm Message and Priority	Possible Cause	Corrective Action
<p>Callback to Line B! Silence audio to clear.</p> <p><b>Medium</b> <b>N104</b></p>	<p>A Callback Alarm was programmed for Line B, which is in Piggyback mode, Line A is programmed to resume when Line B completes, and the VTBI for Line B reaches 0 for a Piggyback therapy, Loading Dose, Maintenance Dose or any step in a multistep therapy.</p> <p>OR</p> <p>A Callback Alarm was programmed for Line B, which is in Piggyback mode, Line A is not programmed to resume when Line B completes, and the VTBI for Line B reaches 0 for a Loading Dose or any step in a multistep therapy except the last step.</p> <p>OR</p> <p>A Callback Alarm was programmed for Line B, which is in Concurrent mode, and the VTBI for Line B reaches 0 for a Loading Dose or any step in a multistep therapy except the last step.</p>	<p>Press [AUDIO PAUSED].</p>

<b>Alarm Message and Priority</b>	<b>Possible Cause</b>	<b>Corrective Action</b>
<p>Proximal OCCLUSION B. Resolve then Backprime <b>Medium</b> <b>N183</b></p>	<p>Proximal occlusion detected on Line B during cassette integrity test.</p>	<p>Examine line B for kinks. Make sure a line or syringe is attached to the secondary port and that the line is unclamped or the syringe has enough free space to accept the backprimed fluid. Either backprime or open and close the cassette door. Check the syringe size. See <a href="#"><i>Administration Sets and Accessories Guidelines</i></a> on page 1-19.</p>
<p>Bolus complete on Line B! Silence audio to clear. <b>Medium</b> <b>N106</b> (software version 15.1 and later)</p>	<p>Bolus delivery completes on Line B and a Nurse Callback was configured.</p>	<p>Press [AUDIO PAUSED].</p>

# Lines A and B Alarms

## High Priority Alarms

Alarm Message and Priority	Possible Cause	Corrective Action
No Action Alarm! Acknowledge Alert. <b>High</b> <b>N101</b>	Rate was recalculated; operator has not acknowledged the alert within 30 seconds.	Press a labeled softkey.
Line not in STANDBY! Choose line(s) to Standby: <b>High</b> <b>N101</b>	No operator action for 15 seconds when the user has selected ▲[Standby] when both lines are able to be put in standby, but has not selected a line (A, B or A & B) or selected ▲[Cancel] to complete the action.	Press ▲[Standby All], ▲[Standby A], ▲[Standby B], or ▲[Cancel].

Alarm Message and Priority	Possible Cause	Corrective Action
<p>Delivery was not STOPPED! Choose line(s) to stop.</p> <p><b>High</b> <b>N101</b></p>	<p>No operator action for 15 seconds when the user has attempted to stop a delivery where both lines are delivering by pressing [STOP], but has not selected a line (A, B or A &amp; B) or selected ▲[Cancel] to complete the action.</p>	<p>Press ▲[Stop All], ▲[Stop A], ▲[Stop B], or ▲[Cancel].</p>
<p>Delivery was not STARTED! Choose line(s) to start.</p> <p><b>High</b> <b>N101</b></p>	<p>No operator action for 15 seconds when the user has attempted to start a delivery where both lines are confirmed by pressing [START], but has not selected a line (A, B or A &amp; B) or selected ▲[Cancel] to complete the action.</p>	<p>Press ▲[Start All], ▲[Start A], ▲[Start B], or ▲[Cancel].</p>

Alarm Message and Priority	Possible Cause	Corrective Action
(software version 15.1 and earlier) Yes: Start titration! No: Edit  (software version 15.11 and later) Yes: Start program No: Edit  <b>High</b> <b>N101</b>	Standby is not possible and no operator action for 30 seconds when a titrated program is waiting to be confirmed.	Press ▲[Yes] to confirm the program or ▲[No] to go back to the Program screen.
No Action Alarm! Yes: Start No: Edit <b>High</b> <b>N101</b>  <b>Note:</b> Standby is intentionally not included in the instruction text.	Standby is possible and no operator action for 2 minutes when a new program is waiting to be confirmed or placed into Standby.	Press ▲[Yes] to confirm the program or ▲[No] to go back to the Program screen, or press ▲[Standby].

Alarm Message and Priority	Possible Cause	Corrective Action
<p>(software version 15.1 and earlier)                      Yes: Start titration!                      No: Edit</p> <p>(software version 15.11 and later)                      Yes: Start program                      No: Edit</p> <p><b>High</b>  <b>N101</b></p> <p><b>Note:</b> Standby is intentionally not included in the instruction text.</p>	<p>Standby is possible and no operator action for 30 seconds when a titrated program is waiting to be confirmed or placed into Standby.</p>	<p>Press ▲[Yes] to confirm the program or ▲[No] to go back to the Program screen, or press ▲[Standby].</p>
<p>(software version 15.1 and earlier)                      No Action Alarm!                      START: Confirm titration.</p> <p>(software version 15.11 and later)                      No Action Alarm!                      START: Confirm program</p> <p><b>High</b>  <b>N101</b></p>	<p>No operator action for 30 seconds when a line is titrated during infusion and the [START] hardkey has not been pressed for a program that can be started.</p> <p><b>Note:</b> A delivery cannot be started if it is in a concurrency violation. If it is in a concurrency violation, an alarm will occur.</p>	<p>Press [START].                      Press ▲[Return to A/B].</p>

Alarm Message and Priority	Possible Cause	Corrective Action
No Action Alarm! Yes: Override No: Edit <b>High</b> <b>N101</b>	Soft limit override and no operator action for 2 minutes when a new program is waiting to be confirmed. OR Soft limit override and no operator action for 30 seconds when a titrated program is waiting to be confirmed.	Press ▲[Yes] to confirm the program or ▲[No] to go back to the Program screen.
No Action Alarm! Start or Clear lines. <b>High</b> <b>N101</b>	No operator action for 2 minutes when both lines have been stopped by the user and not cleared or restarted. OR (software version 15.1 and later) No operator action for 2 minutes after a Bolus has been cancelled (putting both lines into a stopped state). <b>Note:</b> Will reassert if the condition persists.	Press any hardkey except [AUDIO PAUSED].

Alarm Message and Priority	Possible Cause	Corrective Action
<p>No Action Alarm! Yes: Start No: Edit <b>High</b> <b>N101</b></p>	<p>Standby is not possible and there is no operator action for 2 minutes when a new program is waiting to be confirmed.</p>	<p>Press ▲[Yes] or ▲[No].</p>
<p>Proximal AIR! Backprime. <b>High</b> <b>N230</b></p>	<p>The cumulative air detected at the proximal sensors in Line A and Line B exceeds the air detection threshold.</p>	<p>Press ▲[Back Prime]. See <i>Backpriming</i> on page 4-21. Check the syringe size. See <i>Administration Sets and Accessories Guidelines</i> on page 1-19.</p>



## Rejected Auto-Programs

If a physician's order for an automatically programmed therapy (see [Auto-Programming](#) on page 6-1) exceeds the capabilities of the infuser or is above a hospital-defined hard drug limit, the order will be rejected. If your order is rejected, recheck the order.

The following table is a list of auto-program rejection messages and operator actions to respond to rejections.

Message	Action
The program was rejected because there is no custom drug library installed.	Press ▲[Reject], or wait for this screen to automatically dismiss.
The program was rejected because a CCA has not been selected.	Press ▲[Reject], or wait for this screen to automatically dismiss. Select a CCA and resubmit the program.
The program was rejected because the patient weight is different than the weight being used on the other line.	Press ▲[Reject], or wait for this screen to automatically dismiss.
The program was rejected because the patient height is different than the height being used on the other line.	Press ▲[Reject], or wait for this screen to automatically dismiss.
The program was rejected because required information was missing.	Press ▲[Reject], or wait for this screen to automatically dismiss.
The program was rejected because the patient BSA is different than the BSA being used on the other line.	Press ▲[Reject], or wait for this screen to automatically dismiss.
The program was rejected because it contains invalid data.	Press ▲[Reject], or wait for this screen to automatically dismiss.

Message	Action
The program was rejected by ICU Medical MedNet due to drug library incompatibility.	Press ▲[OK], or wait for this screen to automatically dismiss.
The program was rejected because the line is in Standby.	Press ▲[Reject], or wait for this screen to automatically dismiss. Clear this line and resubmit the program.
The program was rejected because the line is in Delayed Start.	Press ▲[Reject], or wait for this screen to automatically dismiss. Clear the line and resubmit the program.
The program was rejected because the dosing units do not match the medication units.	Press ▲[Reject], or wait for this screen to automatically dismiss.
The program was rejected because line A cannot be interrupted.	Press ▲[Reject], or wait for this screen to automatically dismiss.
The program was rejected because the combined rate of line A and line B cannot exceed 500 mL/hr in concurrent mode.	Press ▲[Reject], or wait for this screen to automatically dismiss.
The program was rejected because the rate on each line must be greater than 0.5 mL/hr in concurrent mode.	Press ▲[Reject], or wait for this screen to automatically dismiss.
The program was rejected because there is no confirmed program on this line.	Press ▲[Reject], or wait for this screen to automatically dismiss.
The program was rejected because rate change or titration is not allowed on "No Drug Selected".	Press ▲[Reject], or wait for this screen to automatically dismiss.

Message	Action
The program was rejected because the medication cannot be infused as a Piggyback.	Press ▲[Reject], or wait for this screen to automatically dismiss.
(software version 15.1 and earlier) The program was rejected because the duration cannot be changed.	Press ▲[Reject], or wait for this screen to automatically dismiss.
The program was rejected because the medication on line A cannot be interrupted.	Press ▲[Reject], or wait for this screen to automatically dismiss.
The program was rejected because it is for a different medication / concentration than is currently infusing.	Press ▲[Reject], or wait for this screen to automatically dismiss.
(software version 15.11 and earlier) The program was rejected because there is no remaining volume to be infused (VTBI).	Press ▲[Reject], or wait for this screen to automatically dismiss.
The program was rejected because the line is currently delivering.	Press ▲[Reject], or wait for this screen to automatically dismiss.
The program was rejected because there is an unconfirmed program on the infuser.	Press ▲[Reject], or wait for this screen to automatically dismiss. Resubmit the program.
The program was rejected because a change to a non-rate-based infusion is not supported.	Press ▲[Reject], or wait for this screen to automatically dismiss.
The program was rejected because there is a Loading Dose or Multistep program on this line.	Press ▲[Reject], or wait for this screen to automatically dismiss.

Message	Action
The program was rejected because the infuser is alarming.	Press ▲[Reject], or wait for this screen to automatically dismiss. Clear the alarm and resubmit the program.
The program was rejected because the keypad is locked.	Unlock the keypad and resubmit the program.
The program was rejected because the New Patient question must be answered.	Press ▲[Reject], or wait for this screen to automatically dismiss.
(software version 15.11 and later) The program was rejected because the line has a pending CCA change.	Press ▲[Reject], or wait for this screen to automatically dismiss.
(software version 15.1 and later) The program was rejected because the line is delivering a bolus.	Press ▲[Reject], or wait for this screen to automatically dismiss.
(software version 15.1 and later) The program was rejected because there is no cassette installed.	Press ▲[Reject], or wait for this screen to automatically dismiss.
(software version 15.20 and later) The program was rejected because the pump is in Flush mode.	Press ▲[Reject], or wait for this screen to automatically dismiss.

## Partially Programmed Line

For software version 15.1 and earlier, if an auto-program is received for a partially-programmed line, the auto-program will be rejected.

For software version 15.11 and later, if an auto-program is received for a partially-programmed line, the infuser will clear the partial program and accept the auto-program.

A line is partially programmed when a drug is selected for the line and the line program has not been cleared or confirmed.

## Invalid Titration

In this case, an auto-program is rejected because auto-programming is performed on a line in the PENDING or PUMPING state and the Post Infusion Rate (KVO or RATE) is interpreted as not being a titration.

An infuser with an installed cassette was started. The CCA was selected. Line A was programmed and delivery was started. A barcode was scanned and an order on line A was placed. The auto-program for line A was sent to the infuser.

The infuser determines that the auto-program is a new delivery based on titration rules and rejects the auto-program.

---

---

# Notes

---

---

---

## Section 10

# Cleaning, Maintenance, Storage, and Service

---

## Cleaning the Infuser

The Plum 360 infuser should be cleaned and disinfected prior to first patient use, between patient use, and prior to performing repairs and preventive maintenance. For instructions, see the *Plum 360 Infuser Technical Service Manual*.

The following sections describe how to clean spills that may occur while preparing or operating the infuser at the patient site, and the recommended cleaning supplies.



### **CAUTION**

---

**DO NOT SATURATE THE AIR-IN-LINE DETECTORS BEHIND THE CASSETTE DOOR WITH CLEANING SOLUTIONS.**

---

**DO NOT STERILIZE THE INFUSER BY HEAT, STEAM, ETHYLENE OXIDE (ETO), OR RADIATION.**

---

**DO NOT USE SHARP OBJECTS TO CLEAN ANY PART OF THE INFUSER.**

---



To avoid mechanical or electronic damage, do not immerse the infuser in any fluid.

## Cleaning Procedure

The following procedure describes how to clean nonhazardous spills or soil from the infuser during the course of patient care.

- **Non-hazardous** fluid spills should be wiped up as soon as possible, and not allowed to dry on the infuser.
- **Hazardous** spills (such as blood or chemotherapy drugs) should be processed per facility policy.

### To clean non-hazardous spills or soil at the patient site:

1. Inspect the infuser enclosure, display, and keypad for visible cracks or damage that may allow fluid to reach internal components.



**CAUTION**

---

**DO NOT USE THE INFUSER IF THE ENCLOSURE, KEYPAD, OR DISPLAY IS DAMAGED OR CRACKED.**

---



If damage or cracks are found, replace the infuser.

2. With gloves on, remove a wipe from the dispenser and unfold it to expose the maximum surface area before wiping, or spray an approved cleaning solution on a clean, lint-free cloth.



**CAUTION**

---

**DO NOT SPRAY CLEANING SOLUTIONS TOWARD ANY OPENING IN THE INFUSER.**

---

See [Cleaning Supplies](#) on page 10-3 for approved cleaning solutions.



### 3. Wipe up the spill.

- Use a spiral pattern when wiping, moving from the inner to outer edges of each surface to avoid recontaminating the areas you have already wiped.
- When part of the cleaning cloth or wipe becomes soiled or saturated, start wiping with an unused part.
- Change cloths or wipes as needed to avoid spreading the spill from one area of the infuser to another.
- **Do not allow cleaning fluid to run into internal parts of the infuser.**
- When wiping behind the cassette door, take care to avoid damaging the precision parts of the pumping mechanism.

**NOTE:** If sticky or high-viscosity fluids such as TPN are spilled behind the cassette door, replace the infuser as soon as possible so it can be thoroughly cleaned. Dried, built-up residue from these type of fluids can damage the pumping mechanism.

## Cleaning Supplies

To clean the infuser, use clean, soft, lint-free cloths moistened with an approved cleaning solution or commercial wipes.



### **CAUTION**

---

**CERTAIN SOLUTIONS AND ABRASIVES MAY DAMAGE THE INFUSER. DO NOT USE COMPOUNDS CONTAINING COMBINATIONS OF ISOPROPYL ALCOHOL AND DIMETHYL BENZYL AMMONIUM CHLORIDE.**

---

**PREPARE CLEANING SOLUTIONS AS SPECIFIED BY THE MANUFACTURER TO AVOID INFUSER DAMAGE.**

---

**NOTE:** Disinfecting properties of cleaning solutions vary, and not all cleaning solutions are sanitizers. Check product labeling or consult the manufacturer for specific information.

Approved Cleaning Solutions		
Class of Cleaning Solution	Manufacturer	Preparation
Enzymatic Detergent	ASP EnzoI™ ASP Cidezyme™	Use per manufacturer's recommendations and instructions in this manual.

To obtain additional information on cleaning the infuser, [contact ICU Medical](#).

## Infuser Maintenance

The Plum 360 infuser requires annual preventive maintenance that is performed by qualified service personnel. There is no clinician-required maintenance. See the *Plum 360 Infuser Technical Service Manual* for instructions.

## Battery Maintenance



### **WARNING**

**CONNECT THE AC (MAINS) CORD TO A PROPERLY GROUNDED RECEPTACLE.**



### **CAUTION**

**DO NOT OPERATE THE INFUSER ON PATIENTS WITH THE BATTERY REMOVED. USE OF A PROPERLY MAINTAINED AND CHARGED BATTERY HELPS CONFIRM PROPER OPERATION.**



If the low-battery alarm sounds, connect to AC (mains) power immediately.

**NOTE:** If spare parts other than ICU Medical-approved spare parts are used for battery replacement, the warranty on the Plum 360 infuser shall be void.

The battery system requires annual preventive maintenance. See the *Plum 360 Infuser Technical Service Manual* for instructions. Additionally, there are specific storage conditions for the battery (see notes starting on page 11-3). There is no clinician-required battery maintenance.

The Plum 360 infuser is battery-powered for emergency backup and temporary portable operation. The typical battery operating time with a new and fully charged battery is 7 hours when infusing at 25 mL/hr, and 4 hours at 999 mL/hr.

The battery charges whenever connected to AC (mains) power. If the infuser is switched OFF, recharge takes approximately eight hours. Recharge takes longer if the infuser is turned ON.

To maintain maximum battery charge and to prolong battery life, connect the infuser to AC (mains) power whenever possible. Connect to AC (mains) power to continually charge the battery for emergency use.

## Storage



**WARNING** \_\_\_\_\_  
**CONNECT THE AC (MAINS) CORD TO A PROPERLY GROUNDED RECEPTACLE.**

---



**WARNING** \_\_\_\_\_  
**TO PREVENT BATTERY LEAKAGE, REMOVE THE BATTERY BEFORE STORING THE INFUSER FOR AN EXTENDED PERIOD OF TIME.**

---

Store the infuser connected to AC (mains) power, with the infuser switched OFF using the [ON/OFF] key.



Ensure that access to the (mains) plug is not blocked while using the infuser so that the plug can be disconnected from the mains power receptacle in the event of an emergency.



**INSPECT CORD BEFORE USE.** When plugging in, use straight forward motion.



**INSPECT CORD AFTER USE.** When unplugging, grasp plug and pull straight out. Do not pull cable to unplug.

For storage conditions, including extended storage conditions that can affect battery life, see notes starting on page 11-3.

## Service

The infuser has no user-serviceable parts. In addition:

- Servicing and adjustments must only be performed by ICU Medical personnel or trained, authorized service representatives. Service training is available from ICU Medical. Contact your ICU Medical representative.
- Replacement of fuses, power cord, or other parts must only be performed by ICU Medical personnel or trained, authorized service representatives. See the *Plum 360 Infuser Technical Service Manual* for repair and replacement procedures.
- Circuit diagrams and repair parts lists are available for trained, authorized service representatives. See the *Plum 360 Infuser Technical Service Manual* for more information.

- See the *Plum 360 Infuser Technical Service Manual* for more information for all battery removal and storage information, component part lists, descriptions, calibration instructions, and fuse replacement.
- The Plum 360 infuser can be disconnected from the mains supply by removing the power cord from the wall socket.

---

---

# Notes

---

---

---

## Section 11

# Specifications

---

## Physical

<b>Dimensions:</b>	Approximately 8" H x 8" W x 6" D (20 cm H x 20 cm W x 15 cm D), excluding pole clamp extrusion and power cord storage.
<b>Mass:</b>	Approximately 10 lbs. (4.5 kg) with battery.
<b>Casing:</b>	High-impact plastic.
<b>Expected Service Life:</b>	10 years

**NOTE:** Expected Service Life is defined as the amount of time from the date of implementation that the manufacturer will provide technical service to the device. Technical service involves repairs, technical support questions and troubleshooting, and replacement parts.

**NOTE:** At the end of the infuser's serviceable life, the infuser parts must be recycled by an authorized electronic waste handler. Inappropriate disposal of the device can result into Hazards to the Environment. Refer to the *Plum 360 Infuser Technical Service Manual* or [contact ICU Medical Service Center](#) for the current disposal process or follow your facility procedure for proper disposal of the device.

# Electrical



## **WARNING**

**AT THE END OF THE BATTERY'S SERVICE LIFE, DISPOSE OF THE BATTERY BY DELIVERING IT TO AN AUTHORIZED LEAD-ACID BATTERY RECYCLER.**

<b>Power Requirements:</b>	100 - 120 V <sub>AC</sub> ; 50-60 Hz; 50 VA 220 - 240 V <sub>AC</sub> ; 50-60 Hz; 50 VA
<b>Power Cord:</b>	Hospital-grade AC cord.
<b>Fuses:</b>	Internal and non-replaceable
<b>Electrical Leakage:</b>	Meets IEC 60601-1:2012: Medical Electronic Equipment, Part 1: General Requirements for Basic Safety and Essential Performance.
<b>Battery:</b>	One sealed, lead-acid, rechargeable 6 V battery, internal to device.
<b>Battery Operation:</b>	The typical battery operating time with a new and fully charged battery is 7 hours when infusing at 25 mL/hr, and 4 hours at 999 mL/hr.
<b>Recharge:</b>	The battery charges whenever the infuser is connected to AC (mains) power. The recharge time is up to 8 hours with the device operating at 125 mL/hr on one line.
<b>Nurse Call Interface:</b>	The nurse call interface active state is factory set for Normally-Open (NO). Contact the Technical Services Center to change the device from Normally-Open (NO) to Normally-Closed (NC).
<b>Nurse Call Circuitry Ratings:</b>	Voltage: 30 V <sub>DC</sub> Max current: 1 Amp



**Environment:**

- Operating Temperature: 41°F to 104 °F (5°C to 40 °C)  
See Notes 1 and 2.
- Storage Temperature: –5°F to 104°F (–20°C to 40°C)  
See Notes 2 and 3.
- Atmospheric Pressure: 0 to 10,000 feet (0 to 3,000m)  
or equivalent pressure
- Relative Humidity: 10% to 90% (maximum dew point of 30°C)  
See Note 4

**NOTES:**

1. Batteries operate on electrochemical reaction, which converts chemical energy to electric energy. The electrochemical reaction is reduced as temperature lowers, thus, available discharge capacity is greatly reduced at temperatures as low as –15°C.
2. Battery cycle life (number of cycles) of the battery is dependent on the depth of discharge in each cycle. The deeper the discharge, the shorter the cycle life (smaller number of cycles), providing the same discharge current. The cycle life (number of cycles) of the battery is also related to such factors as the ambient temperature and rest period between charge and discharge. The expected life of the battery will decrease by one-half with each rise in temperature of 10°C. In particular, the life of the battery will shorten at about 40°C. Therefore, careful consideration must be taken not to use or store the battery at high temperature. A permanently damaged battery cannot be recharged to full capacity.
3. The ambient temperature range of storage shall be –15°C to 40°C. For short-term storage (up to 2 weeks), the temperature range of –20°C to 60°C is permissible. For long-term storage (up to 12 months), the optimum temperature range is –15°C to 25°C. When it is unavoidable to store the battery for 3 months or longer, periodically recharge the battery at the intervals recommended in the following table, depending on ambient temperature. Avoid storing the battery for more than 12 months either in the infuser or in spares inventory.

<b>Storage Temperature</b>	<b>Refresh Charge Interval</b>
-15°C to 25°C	6 months
25°C to 40°C	2 months
40°C to 60 °C	1 week

Do not store above 40°C for more than 2 weeks.

If any of the above conditions are not or cannot be met during storage, replace the battery before use.

4. The optimal relative humidity for storage or operation is 25% to 85%. For short durations (up to 2 weeks), operation or storage at a relative humidity in the range of 10% to 90% is permissible.

## Connectivity Engine

<b>Wireless Standards:</b>	IEEE 802.11 a/b/g/n
<b>Radio Technology:</b>	802.11a: Orthogonal Frequency Division Multiplex 802.11b: Direct Sequence Spread Spectrum 802.11g: Orthogonal Frequency Division Multiplex 802.11n: Orthogonal Frequency Division Multiplex
<b>Data Transfer Rate:</b>	802.11a: Up to 54 Mbps 802.11b: Up to 11 Mbps 802.11g: Up to 54 Mbps 802.11n: Up to 72.2 Mbps (2.4 GHz Frequency Band) 802.11n: Up to 72.2 Mbps (5.0 GHz Frequency Band, 20 MHz channel) 802.11n: Up to 150 Mbps (5.0 GHz Frequency Band, 40 MHz channel)

<b>Frequency Band</b>	802.11a: 5.0 GHz
<b>IEEE 802.11b:</b>	802.11b: 2.4 GHz
	802.11g: 2.4 GHz
	802.11n: 2.4 GHz, 5.0 GHz
<b>Transmit Power:</b>	802.11a: +16 dBm (max)
	802.11b: +15 dBm (max)
	802.11g: +15 dBm (max)
	802.11n: +14.5 dBm (max) @ 2.4 GHz
	+16dBm (max) @ 5 GHz
<b>Antenna:</b>	PCB antenna mounted in infuser housing
<b>Ethernet LAN:</b>	Shielded Ethernet cable plugged into an RJ-45 connector
<b>Ethernet Protocol:</b>	DHCP; assigned IP Address, Subnet Mask, Gateway, and DNS
<b>Certifications:</b>	FCC Part 15.247, 15.407
	IC RSS-210, RSS-102
	FCC ID: STJ-SDMAN
	IC No: 5627A-SDMAN

## VTBI Range

<b>VTBI Range:</b>	0.1 to 99.9 mL (in 0.1 mL increments) 100 to 9999 mL (in 1 mL increments)
--------------------	--

## Delivery Rate Range and Duration

<b>Lines A and B:</b>	0.1 to 99.9 mL/hr (in 0.1 mL increments) 100 to 999 mL/hr (in 1 mL increments)
<b>Concurrent Delivery:</b>	0.5 mL/hr minimum for each line
<b>PlumSet:</b>	500 mL/hr cumulative (A+B) maximum
<b>KVO:</b>	1.0 mL/hr or the last delivery rate on the associated line, whichever is less
<b>Bolus Delivery (software version 15.1 and later):</b>	1 to 99.9 mL/hr (in 0.1 mL increments) 100 to 999 mL/hr (in 1 mL increments)
<b>Maximum Programmable Duration:</b>	1500:00 hh:mm

## Air-in-Line Alarm

<b>PlumSet (Distal):</b>	Air Bolus at 0.1 mL or larger Cumulative 0.25 mL out of 4.9 mL
<b>PlumSet (Proximal):</b>	Air Bolus at 0.5 mL Cumulative 1.0 mL

## Occlusion Alarm and Limits

Temperature and length of administration set affect the maximum occlusion detection time.

<b>Distal Occlusion:</b>	The DISTAL OCCLUSION alarm sounds after the distal set tubing or set outlet fitting becomes occluded or vacuum occurs.
--------------------------	--

<b>Proximal Occlusion:</b>	The PROXIMAL OCCLUSION alarm sounds if the tubing proximal to the cassette becomes occluded or pressurized.
<b>Distal Pressure Limit (without alarm):</b>	Maximum pressure limit: user-selectable. Factory default setting: 6 psi (310 mmHg) Selectable range: 1 to 15 psi (52 to 776 mmHg) with display accuracy $\pm 3$ psi ( $\pm 155$ mmHg).
<b>Maximum Infusion Pressure:</b>	20 psi (1034 mmHg)

# Time To Detect Downstream Occlusions

Flow Rate	Distal Pressure Alarm Limit Setting	Distal Tubing Type	Maximum Time to Detect Downstream Occlusion
.1 mL/hr	1 psi (52 mmHg)	Microbore	27 minutes
.1 mL/hr	15 psi (776 mmHg)	Microbore	3 hours
1 mL/hr	1 psi (52 mmHg)	Microbore	2 minutes
1 mL/hr	15 psi (776 mmHg)	Microbore	15 minutes
25 mL/hr	1 psi (52 mmHg)	Microbore	5 seconds
25 mL/hr	15 psi (776 mmHg)	Microbore	30 seconds
.1 mL/hr	1 psi (52 mmHg)	Macrobore	27 minutes
.1 mL/hr	15 psi (776 mmHg)	Macrobore	9 hours
1 mL/hr	1 psi (52 mmHg)	Macrobore	3 minutes
1 mL/hr	15 psi (776 mmHg)	Macrobore	45 minutes
25 mL/hr	1 psi (52 mmHg)	Macrobore	5 seconds
25 mL/hr	15 psi (776 mmHg)	Macrobore	90 seconds
* Baseline backpressure is 0 psi (0 mmHg)*			

# Maximum Unintended Bolus Volume Released After Distal Occlusion is Resolved

Flow Rate	Distal Pressure Alarm Limit Setting	Distal Tubing Type	Maximum Unintended Bolus Volume Released	Typical Unintended Bolus Volume Released
1 mL/hr	1 psi (52 mmHg)	Microbore	0.01 mL	0.00 mL
1 mL/hr	15 psi (776 mmHg)	Microbore	0.17 mL	0.11 mL
25 mL/hr	1 psi (52 mmHg)	Microbore	0.02 mL	0.00 mL
25 mL/hr	15 psi (776 mmHg)	Microbore	0.17 mL	0.12 mL
1 mL/hr	1 psi (52 mmHg)	Macrobore	0.02 mL	0.00 mL
1 mL/hr	15 psi (776 mmHg)	Macrobore	0.67 mL	0.48 mL
25 mL/hr	1 psi (52 mmHg)	Macrobore	0.03 mL	0.00 mL
25 mL/hr	15 psi (776 mmHg)	Macrobore	0.57 mL	0.44 mL
* Baseline backpressure is 0 psi (0 mmHg)*				

# Delivery Accuracy

This table defines the standard conditions for delivery accuracy.

Delivery Accuracy	
0.1 to 0.9 mL/hr (in 0.1 mL increments)	±10%
1 to 999 mL/hr (in 1 mL increments)	±5%
Ambient and Fluid Temperature	22°C ± 5°C
Back Pressure	0 psi (0 mmHg)
I.V. Fluid	Sterile water
Filling Head Height	12" to 24" (30.5 to 61 cm)



## **WARNING**

**DELIVERY ACCURACY MAY POTENTIALLY BE AFFECTED BY SEVERAL USE CONDITIONS, INCLUDING ELEVATED INFUSER HEIGHT, VENOUS HYPERTENSION, PRESENCE OF AIR IN THE CASSETTE AIR TRAP, I.V. SOLUTION VISCOSITY, AND I.V. SOLUTION TEMPERATURE.**

Delivery accuracy testing was performed in accordance with IEC 60601-2-24:2012. Tests were performed using Administration Set List Numbers 12538, 14009, 14022, and 14246.

See [Trumpet Curves](#) on page 11-12 for data on how certain factors influence rate accuracy.



## Bolus Delivery Accuracy

**NOTE:** Bolus dose functionality is available in software version 15.1 and later.

Bolus delivery accuracy testing was performed in accordance with IEC 60601-2-24:2012. Refer to this standard for detailed information.

Bolus Delivery Accuracy data was generated using a representative sample of administration sets from the Plum set portfolio. Tests were performed using Administration Set List Number 14251.

<b>Bolus Delivery Accuracy</b>				
<b>Tested Bolus Rate (in mL/hr)</b>	<b>Tested Bolus Volume (in mL)</b>	<b>Calculated % Average Deviation from Set Bolus Volume</b>	<b>Maximum % Positive Deviation from Set Bolus Volume</b>	<b>Maximum % Negative Deviation from Set Bolus Volume</b>
1 mL/hr	4 mL	-1.40 %	-0.79 %	-3.41 %
25 mL/hr	100 mL	-0.23 %	0.33 %	-1.96 %

## Enteral or High Viscosity Fluids Effects

System delivery accuracy limits for enteral or high viscosity fluids can be degraded by up to 5%. System delivery accuracy for enteral fluids is defined only for rates of 1 to 200 mL/hr, with no suspended air in the solution, and using a Plum enteral set.

# Trumpet Curves

The Trumpet Curve graphs following the example show representative maximum and minimum percent flow rate deviation from the programmed rate over time. This information was developed in accordance with IEC 60601-2-24:2012. Refer to this standard for detailed information.

How to read a Trumpet Curve Graph (Refer to example on the following page): The graphs following the Example plot flow rates at 30 second intervals for the first 2 hours and for the 96th hour of delivery. The graph plots mean delivery rate error for the 2nd hour and the 96th hour as a straight line. The graph also presents maximum and minimum average delivery rate error for this interval plotted by averaging delivery errors over intervals of 2, 5, 11, 19, and 31 minutes (“Trumpet Curve”).

Trumpet Curve data was generated using a representative sample of administration sets from the Plum set portfolio. Tests were performed using Administration Set List Numbers 12538, 14009, 14022, and 14246.

Note that at extremely low flow rates (that is, 0.1–0.3 mL/hr) and at non-standard negative back pressures (-1 psi or -52 mmHg), the accuracy error rate can be up to  $\pm 25\%$ .

**Backpressure Effect** – At 25 mL/hr flow rate, backpressures of +/- 2 psi (103 mmHg) on the distal line do not affect system delivery accuracy.

**Filling Head Effect** – At 25 mL/hr flow rate, filling head variations of -15 and +35 inches (-38 and +89 cm) of water (such as container height) do not affect system delivery accuracy.

**Concurrent Delivery Effect** – When both lines (A & B) are delivering, the concentration deviation for the lower rate may be affected by up to 2.5%.

When air of volume greater than 0.05 mL is present in the cassette air trap, the total system flow rate accuracy may be affected by up to 2.0%.

When variations in container height are present, the concentration deviation for the lower rate may be affected by up to 4.0% for up to 24 inches (61 cm) of container height differences.

## Example

From the Trumpet Curve Graph sample that follows, find the 5 minute interval (A) at the horizontal axis and read the corresponding points (B) and (C) on the vertical axis. The values are approximately +2.8% and -0.5%.

This means that at the rate of 25 mL/hr the average maximum flow rate fluctuation for any 5 minute time interval during the 2nd hour of operation was within the limits of +2.8% and -0.5% from the nominal rate. The average delivery rate error over the entire 2nd hour was +1.6% (D).

For other time intervals look at other points at the horizontal axis and determine corresponding limits as above.

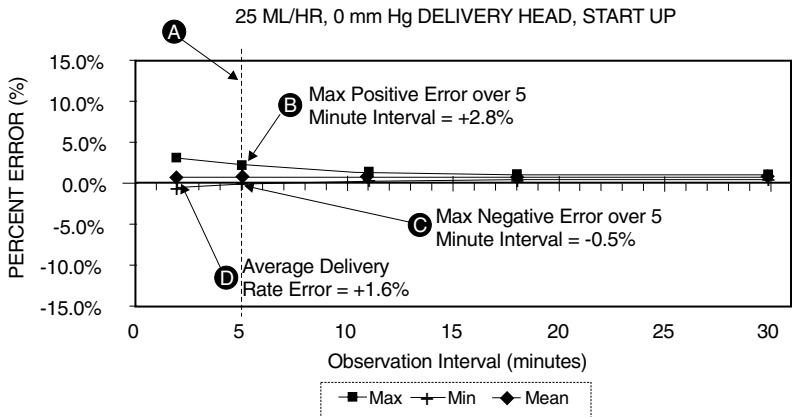

**A trained professional can use the resulting graphs to select an infuser with the appropriate startup and flow characteristics to suit the clinical application.**

**NOTE:** As an example of how the trumpet curves can be used, consider the maximum and minimum deviations at the 5 minute average interval. The upper curve provides the maximum expected

delivery rate error over a 5 minute interval, the lower curve provides the minimum expected delivery rate error over a 5 minute interval. An example would be Dopamine administered at 5  $\mu\text{g}/\text{kg}/\text{min}$ . At 5 minutes, the average drug delivery error would be within the range of +2.8% and -0.5% of the expected nominal rate.

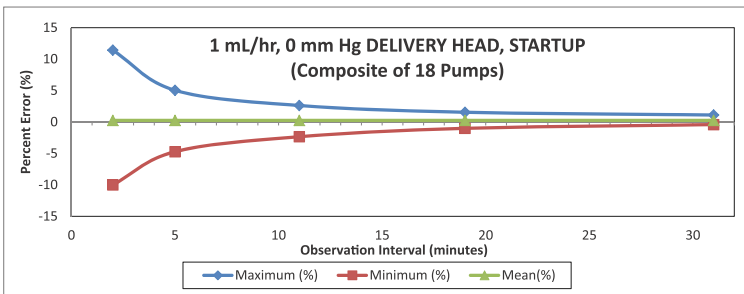
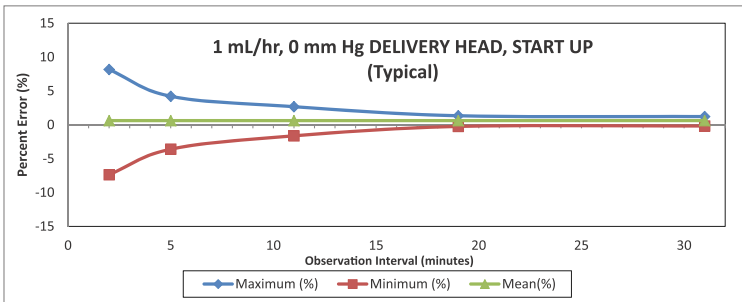
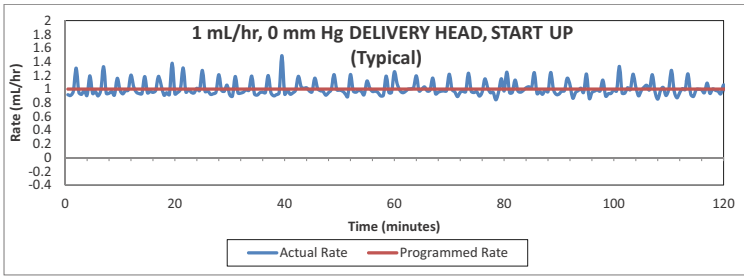

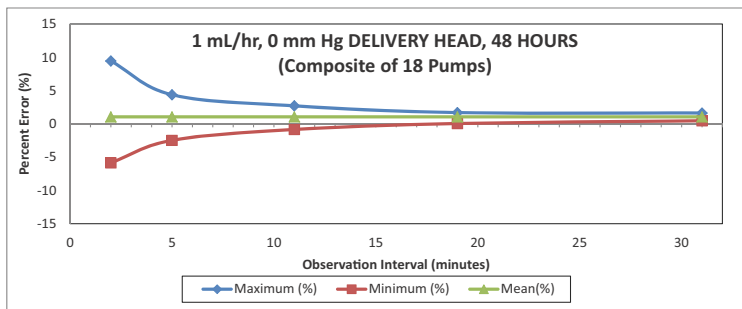
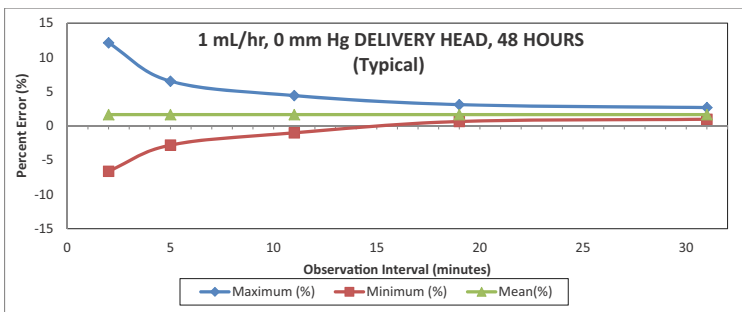
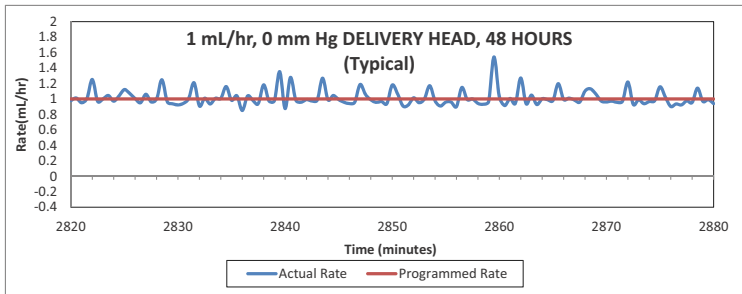

Plum 360 Infuser

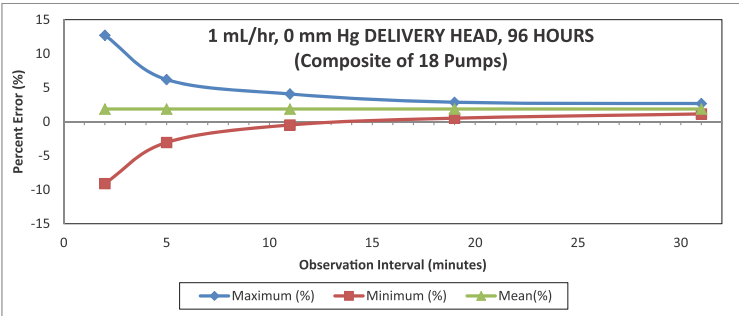
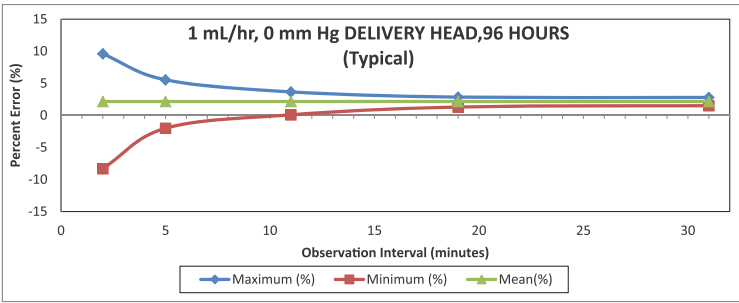
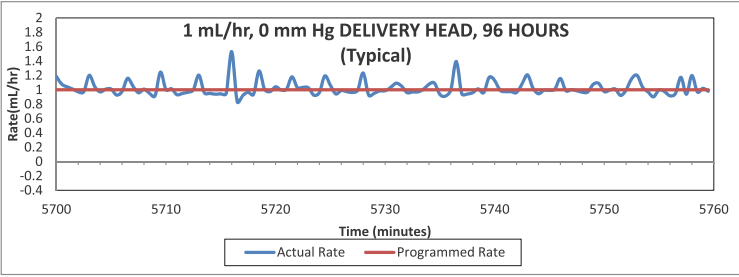

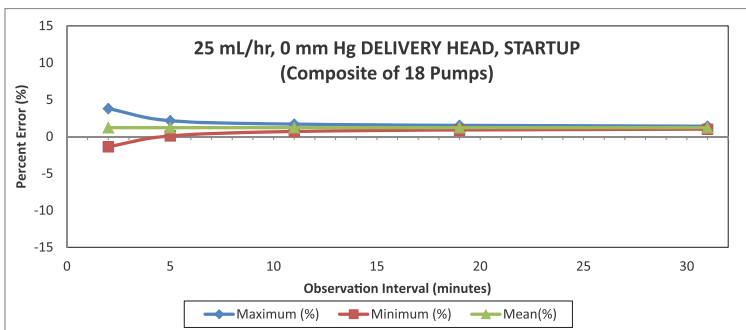
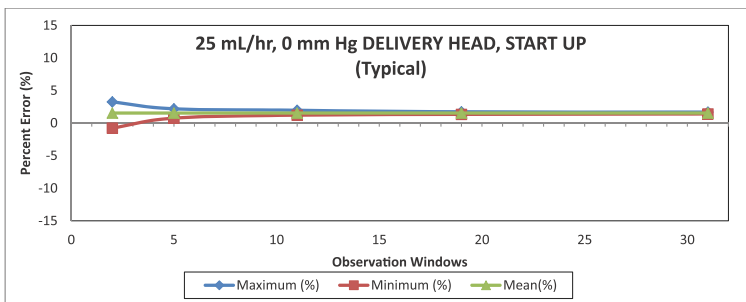
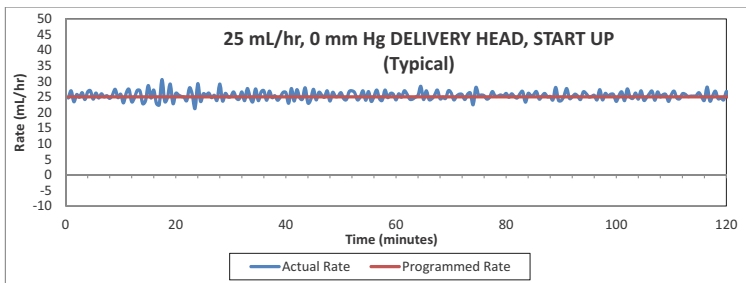

Plum 360 Infuser

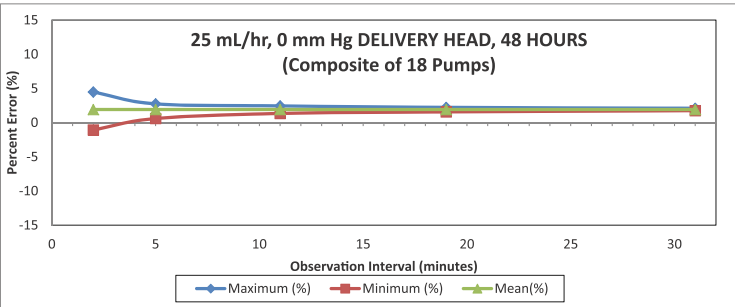
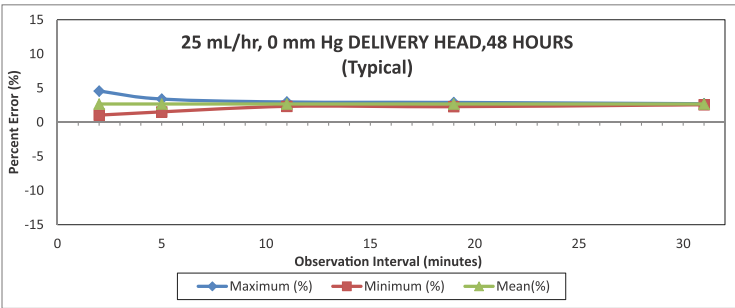
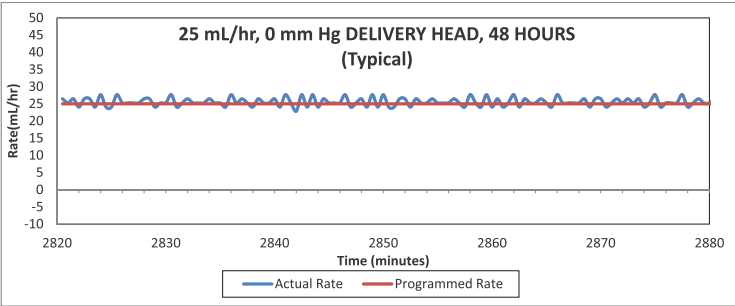



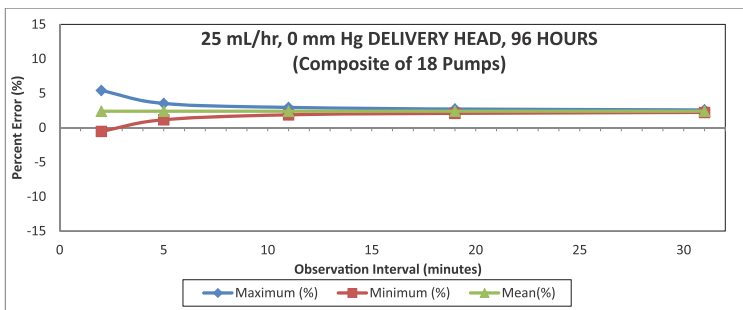
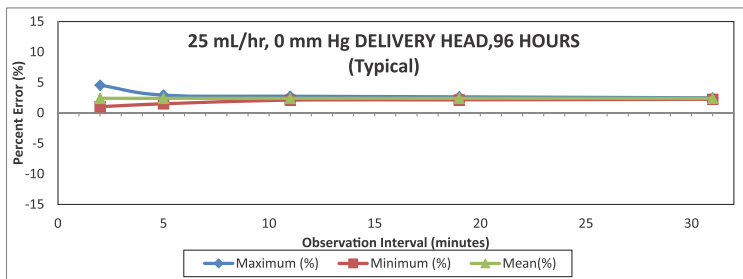
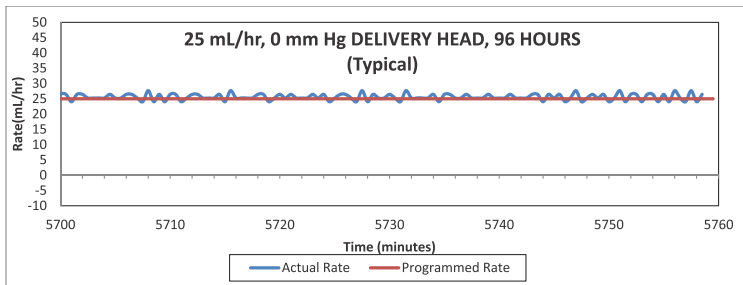

---

---

# Notes

---

---

## Section 12

# Supplies and Accessories

## Administration Sets

The following is a representative list of administration sets that are available for use with the Plum 360 infuser. Some administration sets may not be available in your region. For information about additional compatible administration sets, contact your local sales representative.

### CE Marked Administration Sets

#### Primary I.V. PlumSets

List Number	Description
<b>12193</b>	Primary PlumSet™, 2 Clave™ Multiport Connector, 15 Micron Filter, Clave Port, Clave Y-Site, PE Lined Light Resistant Tubing, 20 drops/mL, 213 cm
<b>12194</b>	Primary PlumSet, 2 Clave Multiport Connector, 15 Micron Filter, Clave Port, Clave Y-Site, PE Lined Tubing, 20 drops/mL, 213 cm
<b>12195</b>	Primary PlumSet, 4 Clave Multiport Connector, 15 Micron Filter, Clave Port, Clave Y-Site, PE Lined Light Resistant Tubing, 20 drops/mL, 216 cm
<b>12196</b>	Primary PlumSet, 4 Clave Multiport Connector, 15 Micron Filter, Clave Port, Clave Y-Site, PE Lined Tubing, 20 drops/mL, 216 cm
<b>14000</b>	Primary PlumSet, 15 Micron Filter in Sight Chamber, Capped Port, Prepierced Y-Site, 20 drops/mL, 272 cm
<b>14001</b>	Primary PlumSet, 15 Micron Filter in Sight Chamber, Clave Port, Clave Y-Site, 20 drops/mL, 272 cm

List Number	Description
<b>14006</b>	Primary PlumSet, 15 Micron Filter in Sight Chamber, Capped Port, PE Lined Light Resistant Tubing, Distal Microbore Tubing, 20 drops/mL, 272 cm

## Secondary I.V. Set

---

List Number	Description
<b>14028</b>	Secondary Set, 15 Micron Filter in Sight Chamber, 20 drops/mL, 86 cm

## Burettes

---

List Number	Description
<b>14003</b>	Plum 150 mL Burette Set, Prepierced Additive Port, 15 Micron Filter in Sight Chamber, Prepierced Secondary Port, 2 Prepierced Y-Sites, 20 drops/mL, 290 cm
<b>12564</b>	Plum 150 mL Burette Set, Clave Additive Port, 15 Micron Filter in Sight Chamber, 2 Clave Y-Sites, 20 drops/mL, 290 cm

## Blood Sets

---

List Number	Description
<b>14211</b>	Plum Blood Set, 200 Micron Filter, Prepierced Secondary Port, 20 drops/mL, 279 cm
<b>14212</b>	Plum Blood Set Y-Type, 200 Micron Filter, Clave Secondary Port, 20 drops/mL, 279 cm

## Enteral Sets

---

List Number	Description
<b>14025</b>	Enteral PlumSet, Integral Container, Enteral Catheter Adapter, 20 drops/mL, 264 cm
<b>14259</b>	Primary Enteral PlumSet, 40mm Screw Cap, Enteral Catheter Adapter, 20 drops/mL, 249 cm

## Non-CE Marked Administration Sets

### Primary I.V. PlumSets

---

List Number	Description
<b>14243</b>	Primary PlumSet, Capped Port, 2 Clave Y-Sites, 15 drops/mL, 104 Inch
<b>14247</b>	Primary PlumSet, Capped Port, Clave Y-Site, Distal Microbore Tubing, 15 drops/mL, 104 Inch
<b>14254</b>	Primary PlumSet, Clave Port, 2 Clave Y-Sites, 0.2 Micron Filter, 15 drops/mL, 112 Inch
<b>14687</b>	Primary PlumSet, Clave Port, Clave Y-Site, 15 drops/mL, 103 inch

## Secondary I.V. Set

---

List Number	Description
<b>14230</b>	Secondary Set, Macrobore, Extension Hook, 15 drops/mL, 34 Inch

## Burettes

---

List Number	Description
<b>11948</b>	Burette PlumSet, Capped Port, Microdrip 150 mL Burette, Clave Additive Port, Capped Secondary Port, 2 Clave Y-sites, 60 drops/mL, 124 inch Clave
<b>14271</b>	Burette PlumSet, Microdrip 150 mL Burette, Clave Additive Port, Clave Secondary Port, 0.2 Micron Filter, 3 Clave Y-Sites, 60 drops/mL, 140 Inch
<b>14272</b>	Burette PlumSet, Microdrip 150 mL Burette, Prepierced Additive Port, Prepierced Secondary Port, 2 Prepierced Y-Sites, 60 drops/mL, 114 Inch

## Blood Sets

---

List Number	Description
<b>14211</b>	Primary Plum Blood Set, Clave Secondary Port, 200 Micron Filter, Secure Lock, 110 Inch
<b>14212</b>	Plum Y-Type Blood Set, 200 Micron Filter, Clave Port, 20 drops/mL, 110 Inch
<b>14220</b>	Plum Y-Type Blood Set, 200 Micron Filter, Clave Port, Clave Y-Site, 20 drops/mL, 110 Inch

## Enteral Sets

---

List Number	Description
14257	Primary Enteral PlumSet, Enteral Adapter, 15 drops/mL, 98 Inch
14258	Primary Enteral PlumSet, 40 mm Screw Cap, Enteral Adapter, 15 drops/mL, 98 Inch
14260	Primary Enteral PlumSet, Integral Container, Enteral Adapter, 15 drops/mL, 103 Inch

## For Epidural Administration

---

List Number	Description
14261	Primary PlumSet, Yellow Striped Tubing, Distal Microbore Tubing, 15 drops/mL, 107 Inch

# Administration Fluids

The Plum 360 infuser is intended for parenteral, enteral, and epidural therapies and the administration of whole blood and blood products.

## Containers

The Plum 360 infuser and its compatible administration sets support a wide variety of containers, including:

- Dual Chamber Parenteral flexible container (Nutrimix™)
- Large Volume Parenteral flexible plastic containers
- Large Volume Parenteral glass containers
- Part Fill Parenteral flexible plastic containers, including ADD-Vantage™
- Part Fill Parenteral glass containers
- Small Volume Parenterals
- Syringes - minimum 3 mL, maximum 60 mL  
(Small volume syringes, i.e., 3-10 mL, require a vented syringe adapter to ensure delivery accuracy and reduce proximal occlusion alarms.)
- Top Filled Enteral bags
- Ready-to-Hang Enteral solution containers



## Accessories

The Plum 360 infuser is compatible with the types of accessories presented in the table below and in the explanatory sections that follow it.

**NOTE:** Contact your local ICU Medical representative for accessories available in your area. Not all accessories are CE marked.

List Number	Description
13852	Nurse Call Cable
13853	Mini Pole

### Tandem Carrier

The Tandem Carrier has been tested for stability requirements of IEC 60601-1:2012 using List Number 39001 I.V. Pole with locking casters. The Tandem Carrier can be used in mobile and non-mobile situations. Follow these directions to ensure stability in mobile use.

1. Obtain an I.V. Pole (six wheel type with six locking casters) to mount the Tandem Carrier.
2. Rotate the carrier clamp wheel to open the clamp sufficiently to be able to slide the carrier onto the I.V. Pole.
3. Prevent the I.V. Pole from moving while sliding the carrier onto the I.V. Pole.
4. Choose a mounting position for the carrier that is NOT GREATER than the maximum allowed mounting height as shown in the picture.
5. Tighten the carrier clamp so that it grips the pole firmly.
6. Pull downward on the carrier. Confirm that the carrier does not slide down the pole.
7. Attach an infuser to each arm of the carrier.

8. Check the I.V. Pole and Carrier assembly for stability and tight mounting connections. **If the assembly is NOT STABLE, check the mounting height of the Tandem Carrier and the extension height of the I.V. Pole. Adjust those settings until the assembly is stable.**

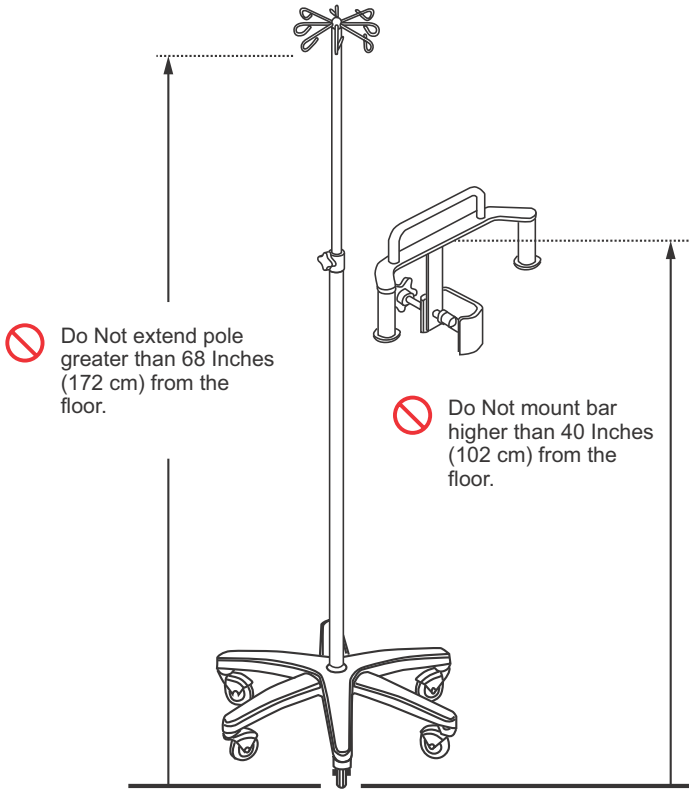

The Tandem Carrier/I.V. Pole system was tested to a maximum mobile load of 23.3 kilograms using 4 one-liter I.V. bags at a height of 68 inches (172 cm) and the Carrier mounted 40 inches (102 cm) above the floor. Those values represent the maximum settings for the system to comply with the mobile stability requirements of IEC 60601-1:2012.

## Multiple Device Adapter

The Multi-device Adapter (MDA) has been tested for stability according to the requirements of IEC 60601-1:2012 using List Number 39001 I.V. Pole with locking casters. **The MDA may only be used in non-mobile situations.** Follow these directions to ensure stability in non-mobile use.

1. Obtain an I.V. Pole (six wheel type with six locking casters) to mount the MDA.
2. For the upper and lower I.V. Pole clamp pieces: Loosen and remove the two screws that hold the semi-circular clamp pieces together. (Each screw has a lock washer. Use care to not lose the lock washer.)
3. Prevent the I.V. Pole from moving while attaching each clamp to the I.V. Pole shaft.
4. Mount the accessory as shown in the picture. Ensure that the upper mounting block recess rests on the I.V. Pole clamp collar.
5. Tighten the MDA clamps so that they grip the pole firmly.
6. Pull downward on the MDA. Confirm that the MDA does not slide down the pole.
7. Attach infusers to each arm of the MDA. **Balance the loading of infusers.** For example, if mounting three infusers, do not mount all three infusers on one side of the MDA, mount two infusers on one side of the MDA and the remaining infuser on the other side of the MDA.
8. Check the I.V. Pole and MDA/Infuser assembly for stability and tight mounting connections. **If the assembly is NOT STABLE, check the infusers mounting position(s) on the MDA and the extension height of the I.V. Pole. Adjust those settings until the assembly is stable.**

# Plum 360 Infuser

Position top bracket slot to fit around knob and recess in upper mounting block to rest on collar of IV Pole clamp.

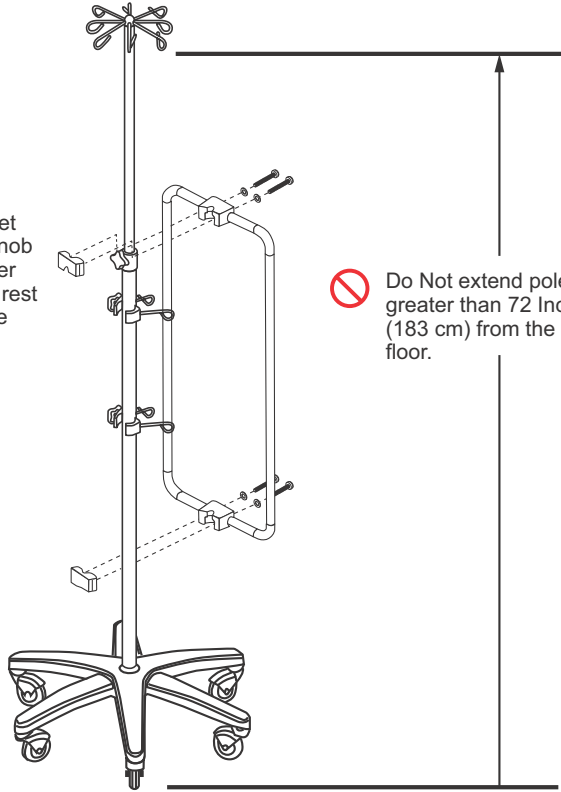

Do Not extend pole greater than 72 Inches (183 cm) from the floor.

The MDA/I.V. Pole system was tested to a maximum non-mobile load of 49.5 kilograms using 6 Plum Infusers and 12 one-liter I.V. bags at a height of 72 inches (183 cm) above the floor. Those values represent the maximum settings for the system to comply with the non-mobile stability requirements of IEC 60601-1:2012.

## I.V. Pole

An I.V. Pole with locking casters has been tested for stability according to the requirements of IEC 60601-1:2012. The I.V. Pole can be used in mobile and non-mobile situations. Follow these directions to ensure stability in **mobile use**.

- **For Mobile Use**, the I.V. Pole may not have more than three (3) infusers mounted to the pole, may not be extended higher than 68 inches from the floor, and not have more than 2000 mL of solution hanging from the I.V. Pole hangers. See the illustration on page 12-12 for the allowable positions of the infusers.
- For Mobile Use, the I.V. Pole may also accept the Tandem Carrier accessory. See [Tandem Carrier](#) on page 12-7.
- For Non-mobile Use, the I.V. Pole can accept the Multi Device Adapter (MDA). See [Multiple Device Adapter](#) on page 12-9.
- After mounting infusers, check the I.V. Pole/infusers assembly for stability and tight mounting connections. **If the assembly is NOT STABLE, check the mounting heights and the extension height of the I.V. Pole. Adjust those settings until the assembly is stable.**

The Infuser/I.V. Pole system was tested to a maximum mobile load of 24.0 kilograms using 2 one-liter I.V. bags at a height of 68 inches (173 cm) and the infusers mounted at 50, 40, and 30 inches (127, 102, and 76 cm) above the floor. Those values represent the maximum settings for the system to comply with the mobile stability requirements of IEC 60601-1:2012.

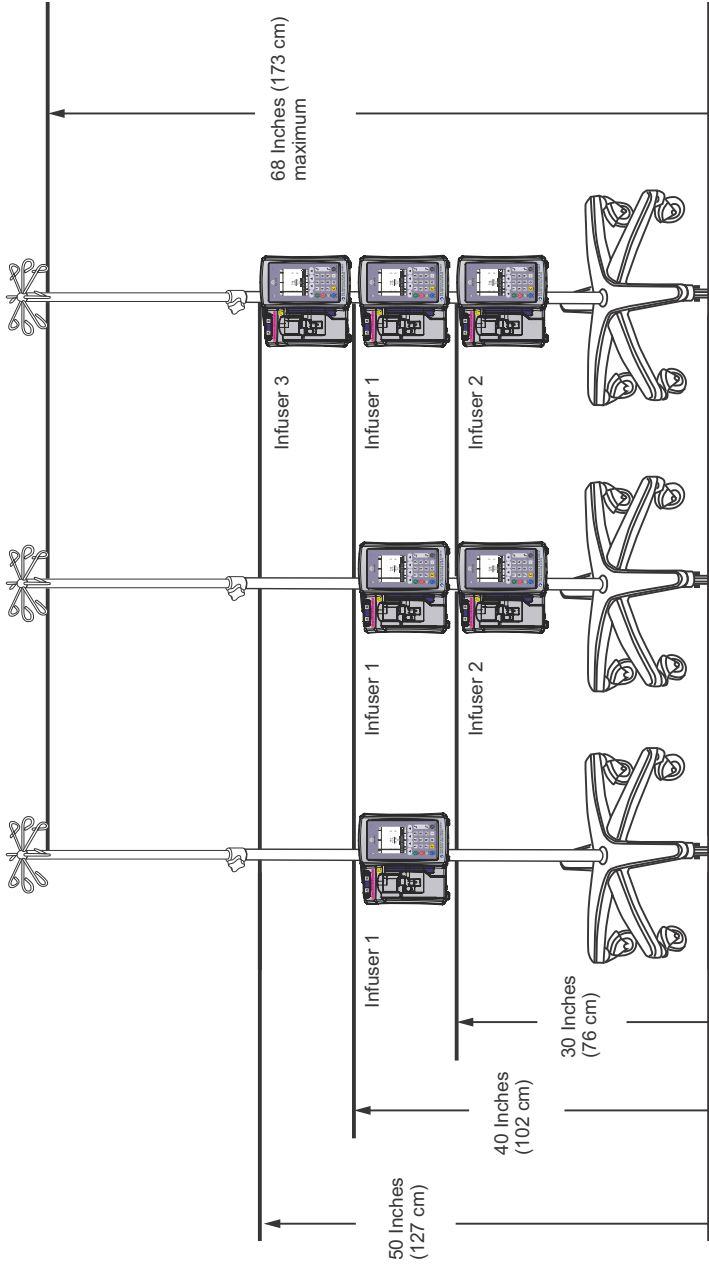

## T-bar Accessory

The T-bar Accessory (T-BA) can be mounted to an I.V. Pole as shown in the diagram below. It can be used in mobile and non-mobile situations.

1. Obtain an I.V. Pole (six wheel type with six locking casters) to mount the T-BA.
2. Rotate the T-BA clamp wheel to open the clamp sufficiently to be able to slide the T-BA onto the I.V. Pole.
3. Prevent the I.V. Pole from moving while sliding the T-BA onto the I.V. Pole.
4. Choose a mounting position for the upper T-BA that is NOT GREATER than the maximum allowed mounting height as shown in the picture.
5. Tighten the T-BA clamp so that it grips the pole firmly.
6. Pull downward on the T-BA. Confirm that the T-BA does not slide down the pole.
7. Attach the desired container or hanging style component to the T-BA.
8. Check the I.V. Pole and T-BA for stability and tight mounting connections.
9. Repeat the mounting steps for the lower T-BA. It can be mounted anywhere below the upper T-BA.

Plum 360 Infuser

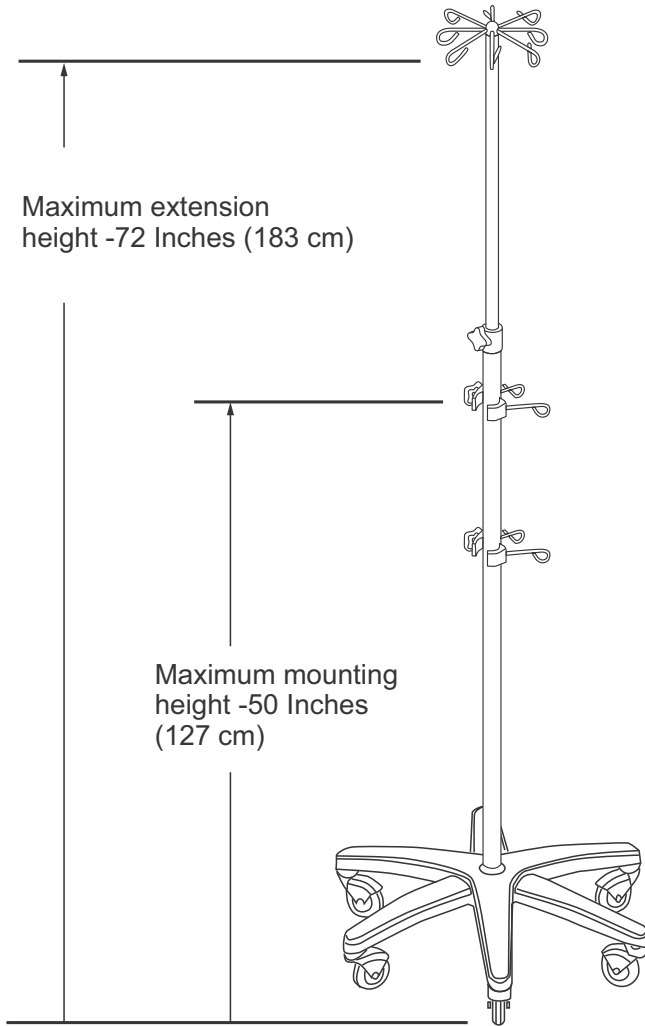



## I.V. Mini-Pole

The I.V. Mini-Pole (MP) mounts to the rear pole clamp frame of the Plum 360 infuser as shown in the diagram below. It can be used in mobile and non-mobile situations.

1. Remove the Locking Clip from the pole shaft.
2. Slide the two shafts of the mini-pole into the two holes in the infuser pole clamp.
3. Adjust the pole to the desired height.
4. Push the locking clip through the shaft hole.
5. Confirm that the Mini-Pole is secure in the infuser pole clamp.

### To remove the MP:

1. Remove the locking clip.
2. Rotate the clutch handle to lessen the spring grip of the MP.
3. Pull up on the MP and pull it out of the pole clamp.

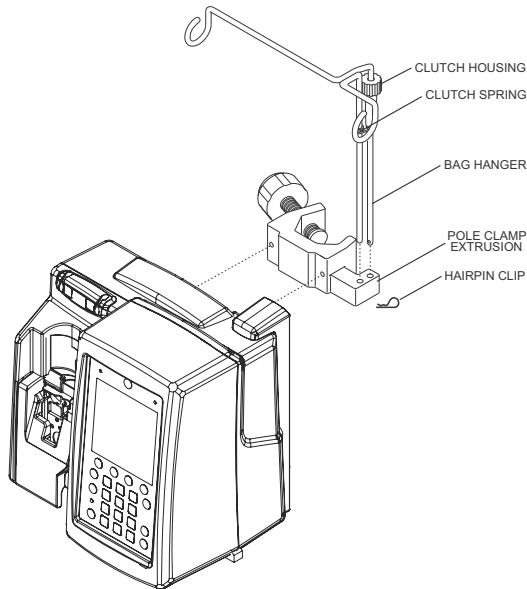

# ICU Medical MedNet Safety Software

ICU Medical MedNet is a server-based safety software application that manages infusion information across ICU Medical infusion platforms including the Plum 360, Plum A+, and LifeCare PCA™ systems. ICU Medical MedNet software facilitates networked communication between the server and ICU Medical MedNet-compatible infusers.

ICU Medical MedNet safety software facilitates best practices to streamline clinical workflows.

- Pharmacy-validated I.V. administration protocols are available to clinicians at the point of care
- Upper and lower dosing limits help protect against infusion errors
- Hard and soft limits create a clinically acceptable range to guide clinicians based on hospital and clinical care area practices

ICU Medical MedNet safety software delivers standard performance reports that enable hospital staff to:

- Assess medication infusion practices in the hospital
- Track clinician drug library utilization or compliance
- Identify I.V. administration practices that can be improved
- Highlight medication use to simplify the drug library
- Identify management issues that can be altered to save costs
- Assess rule set (hard/soft limits) alignment with clinical practice

ICU Medical MedNet software is a modular system capable of managing system users, infusers, drug libraries, clinical care areas, I.V. medication rule sets, infuser software updates, as well as system and infuser configurations.

ICU Medical MedNet software can also be integrated with third-party applications to provide I.V. Clinical Integration, which connects pharmacy validated medication orders with the I.V. infuser, the patient and the patient's electronic medical record (EMR). Other third party applications enable additional functions such as infuser asset management and tracking, and infuser alarm forwarding.

Contact your ICU Medical sales representative for ordering and implementation information.

## **Loss of Communication**

If the Plum 360 infuser loses communication with ICU Medical MedNet software, it will continue to infuse without interruption. However, log content and status will not be sent and auto-programs and software/drug library updates will not be received until communication is restored.

---

---

# Notes

---

---

---

## Section 13

# Warranty

---

Subject to the terms and conditions herein, ICU Medical, Inc., herein referred to as ICU Medical, warrants that (a) the product shall conform to ICU Medical's standard specifications and be free from defects in material and workmanship under normal use and service for a period of one year after purchase, and (b) the replaceable battery shall be free from defects in material and workmanship under normal use and service for a period of 90 days after purchase. ICU Medical makes no other warranties, express or implied, as to merchantability, fitness for a particular purpose, or any other matter.

Purchaser's exclusive remedy shall be, at ICU Medical's option, the repair or replacement of the product. In no event shall ICU Medical's liability arising out of any cause whatsoever (whether such cause be based in contract, negligence, strict liability, other tort, or otherwise) exceed the price of such product, and in no event shall ICU Medical be liable for incidental, consequential, or special damages or losses or for lost business, revenues, or profits. Warranty product returned to ICU Medical must be properly packaged and sent freight prepaid.

The foregoing warranty shall be void in the event the product has been misused, damaged, altered, or used other than in accordance with product manuals so as, in ICU Medical's judgment, to affect its stability or reliability, or in the event the serial number or lot number has been altered, effaced, or removed.

The foregoing warranty shall also be void in the event any person, including the Purchaser, performs or attempts to perform any major repair or other service on the product without having been trained by an authorized representative of ICU Medical and using ICU Medical documentation and approved spare parts. For purposes of the preceding sentence, "major repair or other service" means any repair or service other than the replacement of accessory items such as batteries and detachable mains power cords.

However, the foregoing warranty also shall be voided if any person, including the Purchaser, uses other than ICU Medical-approved spare parts for replacement of batteries.

In providing any parts for repair or service of the product, ICU Medical shall have no responsibility or liability for the actions or inactions of the person performing such repair or service, regardless of whether such person has been trained to perform such repair or service. It is understood and acknowledged that any person other than an ICU Medical representative performing repair or service is not an authorized agent of ICU Medical.

---

## Section 14

# CCAs and Drug Libraries

---

Plum 360 infuser programming is based on the concepts of a Clinical Care Area (CCA) with a Drug Library and infuser settings that support the needs of the CCAs patient population.

When ICU Medical MedNet software is installed, the infuser can download multiple CCAs, each with its own Custom Drug Library (CDL) and infuser settings.

When the Plum 360 infuser is used without ICU Medical MedNet software, the infuser has a single default CCA with associated infuser settings and a drug library. The CCA and the drug library are both called the DDL (Default Drug Library).

This section describes how the DDL and Custom Drug Libraries work. It also lists the Dosing Units that are available when programming a delivery, the allowable input ranges for each dosing unit, and the upper and lower limits that are enforced by the infuser when you enter patient data while programming a delivery.

## DDL CCA and Drug List

The DDL CCA includes an extensive list of commonly-infused drugs, and a group of default infuser settings. It is only available if no custom drug library has been installed on the infuser using ICU Medical MedNet software.

If an infuser does not have ICU Medical MedNet software installed, the DDL offers you the capability of programming the infuser without using the drug list. You can program mL/hr dosing units in single step (single rate) delivery. Alternatively, two delivery options – Loading Dose and Multistep – offer multiple step (multiple rate) delivery. These options enable you to program multiple steps and multiple delivery rates, including mL/hr delivery, with a named drug.

**NOTE:** Once a custom drug library has been installed, the DDL CCA and its default drug list will no longer be available. To restore the DDL, see the *Plum 360 Infuser Technical Service Manual*.

When you select a drug from the DDL during programming, the selected drug appears on the delivery screen, allowing the clinical team to see what drug is being delivered. In addition, you **must** select a drug from the DDL to program any delivery type other than mL/hr.

## Default Dosing Unit and Concentration

---

Each drug in the DDL has a preselected Default Dosing Unit based on the manufacturer's recommendations. This dosing unit is provided for convenience and can be changed when you program a delivery.

In addition, if the drug is formulated as a concentration dissolved in a diluent (mg/mL, for example), the DDL information includes a Default Concentration, which can also be changed during programming.

## DDL Drug List

---

The following table lists the 113 drugs, including No Drug Selected, in the DDL, with their assigned Default Dose Rate and Dose Concentration. Use drug manufacturer recommendations for I.V. administration when using the Plum 360 infuser.

**NOTE:** Capitalization and tall man lettering in Drug Names will differ for software versions 15.1 and earlier.



<b>Drug Name</b>	<b>Dosing Units</b>	<b>Default Concentration</b>
No Drug Selected	mL/hr	N/A
abciximab	mcg/kg/min	mg/mL
acetaminophen	mg/hr	mg/mL
acyclovir	mL/hr	N/A
albumin	mL/hr	N/A
aldesleukin	mL/hr	N/A
alteplase (rt-PA)	mg/kg/hr	mg/mL
aminophylline	mg/hr	mg/mL
amiodarone	mg/min	mg/mL
amiodarone-BOLUS	mL/hr	N/A
amphotericin B	mg/kg/hr	mg/mL
ampicillin	mg/hr	mg/mL
argatroban	mcg/kg/min	mg/mL
azithromycin	mL/hr	N/A
bevacizumab	mg/kg	mg/mL
bivalirudin	mg/hr	mg/mL
bleomycin	mL/hr	N/A
Blood Products	mL/hr	N/A
calcium gluconate	mL/hr	gms/mL
CARBOplatin	mL/hr	N/A
carmustine	mg/m <sup>2</sup>	mg/mL
ceFAZolin	mL/hr	N/A
cefepime	mL/hr	N/A
cefoperazone	mL/hr	N/A

Drug Name	Dosing Units	Default Concentration
cefotaxime	mL/hr	N/A
ceftAZidime	mL/hr	N/A
cefTRIAXone	mL/hr	N/A
cetuximab	mg/m <sup>2</sup> /hr	mg/mL
ciprofloxacin	mL/hr	N/A
CISplatin	mL/hr	N/A
clindamycin	mL/hr	N/A
cyclophosphamide	mL/hr	N/A
cytarabine	mL/hr	N/A
dacarbazine	mg/m <sup>2</sup> /min	mg
dexamethasone	mg/hr	mg/mL
dexmedetomidine	mcg/kg/hr	mcg/mL
dilTIAZem	mg/hr	mg/mL
DOBUTamine	mcg/kg/min	mg/mL
DOCEtaxel	mL/hr	N/A
DOPamine	mcg/kg/min	mg/mL
DOXOrubicin	mL/hr	N/A
EPINEPHrine	mcg/min	mg/mL
epiRUBicin	mg/m <sup>2</sup> /min	mg/mL
epoprostenol	ng/kg/min	mg/mL
eptifibatide	mcg/kg/min	mg/mL
esmolol	mcg/kg/min	mg/mL
etoposide	mL/hr	N/A
famotidine	mL/hr	N/A
fentaNYL	mL/hr	N/A
fluconazole	mL/hr	N/A

<b>Drug Name</b>	<b>Dosing Units</b>	<b>Default Concentration</b>
flumazenil	mL/hr	N/A
folinic acid	mg/m <sup>2</sup>	mg/mL
fosphenytoin	mL/hr	mg/mL
furosemide	mL/hr	N/A
gemcitabine	mg/m <sup>2</sup> /min	mg/mL
gentamicin	mL/hr	N/A
heparin	units/hr	units/mL
heparin wt-based	units/kg/hr	units/mL
HYDROMorphone	mL/hr	N/A
ifosfamide	mL/hr	N/A
immune globulin	mL/hr	N/A
InFLIXimab	mL/hr	mg/mL
insulin	units/hr	units/mL
irinotecan HCl	mg/m <sup>2</sup> /min	mg/mL
IV Maint Fluid	mL/hr	N/A
IV Maint Fluid w/KCl	mL/hr	N/A
labetalol	mg/min	mg/mL
lepirudin	mg/kg/hr	mg/mL
leucovorin	mL/hr	N/A
levETIRAcetam	mL/hr	mg/mL
levoFLOXacin	mL/hr	N/A
lidocaine	mg/min	grams/mL
LORazepam	mL/hr	N/A
magnesium	grams/hr	grams/mL
mannitol	grams/hr	grams/mL
mesna	mL/hr	N/A

Drug Name	Dosing Units	Default Concentration
methotrexate	mL/hr	N/A
methylPREDNISolone	mg/kg/hr	mg/mL
metoclopramide	mL/hr	N/A
metroNIDAZOLE	mL/hr	N/A
midazolam	mL/hr	N/A
milrinone	mcg/kg/min	mg/mL
mitoMYcin	mg/m <sup>2</sup>	mg/mL
morphine	mg/hr	mg/mL
nafcillin	mL/hr	N/A
nitroglycerin	mcg/min	mg/mL
nitroprusside	mcg/kg/min	mg/mL
norepinephrine	mcg/min	mg/mL
ondansetron	mL/hr	N/A
oxacillin	mL/hr	N/A
oxaliplatin	mg/m <sup>2</sup> /hr	mg/mL
oxytocin	mUn/min	units/mL
PACLitaxel	mL/hr	N/A
pantoprazole	mg/min	mg/mL
penicillin	mL/hr	N/A
phenylephrine	mcg/min	mg/mL
piperacillin-tazobactam	mL/hr	grams/mL
potassium	mEq/hr	mEq/mL
procainamide	mg/min	grams/mL
propofol	mcg/kg/min	mg/mL
raltitrexed	mg/m <sup>2</sup> /min	mg/mL

<b>Drug Name</b>	<b>Dosing Units</b>	<b>Default Concentration</b>
raNITidine	mL/hr	N/A
riTUXimab	mg/hr	mg/mL
tobramycin	mL/hr	N/A
TPN	mL/hr	N/A
trastuzumab	mg/kg	mg/mL
urokinase	mL/hr	N/A
valproate sodium	mL/hr	mg/mL
vancomycin	mL/hr	N/A
vasopressin	units/min	units/mL
verapamil	mL/hr	N/A
vinBLASine	mg/m <sup>2</sup>	mg/mL
vinCRISine	mL/hr	N/A

## DDL CCA and Infuser Settings

---

When the infuser is operating under the DDL CCA, it has the following CCA and infuser settings:

CCA Settings:

Maximum Rate:	999	mL/hr
Maximum VTBI (software versions 15.20 and later):	9999	mL
Maximum Patient Weight:	500	kg
Minimum Patient Weight:	0.1	kg
Maximum Patient Height:	305	cm
Minimum Patient Height:	7.5	cm
Maximum Patient BSA:	7.07	m <sup>2</sup>
Minimum Patient BSA:	0.012	m <sup>2</sup>
Default Distal Alarm Pressure:	6	psi (310 mmHg)
Distal Alarm Resets:	0	
Allow Standby:	Yes	
Allow Delayed Start:	Yes	
Default End of Infusion:	KVO	

**NOTE:** For software version 15.11 and earlier, Default End of Infusion is an Infuser Setting.

Infuser Settings:

Default B Delivery Mode:	Piggyback
Default Nurse Callback:	No
Maximum Standby Time:	72 hours

See [Viewing CCA and Infuser Settings](#) on page 3-31 for descriptions of these settings.

## Custom Drug Library (CDL)

ICU Medical MedNet safety software enables your facility to build a custom list of CCAs. Each CCA has its own CDL, to incorporate pharmacy-validated I.V. administration practices for each CCA's patient population.

Every drug in a CDL is assigned upper and lower dosing limits to help protect against infusion errors. These dosing limits can be specified as hard and soft limits, to create a clinically acceptable range for each drug based on hospital and CCA practices.

- **Soft limits** trigger an alarm that can be overridden during programming. When a soft limit is overridden, the delivery screen displays one of these symbols next to the drug during delivery:



Upper Soft Limit Override

Lower Soft Limit Override

- A custom drug library may contain up to the following:

Clinical Care Areas (CCAs)	40
Medications per CCA	400
Total Medications	2,500 <sup>a</sup>

- a. Each drug counts only once, even when used in multiple CCAs

The hard and soft limits together comprise a **Rule Set**.

For software version 15.20 and later, a clinical advisory for a medication may be defined in the drug library. This advisory will display when the associated medication is selected while manually programming the infuser and must be acknowledged before programming can continue.

See the *ICU Medical MedNet Meds Software User Guide* for more information about custom drug libraries and how to build them.

## Dosing Units and Allowable Ranges

The following table lists the dosing units available with the Plum 360 infuser, the allowable input ranges, and the increment values for each range.

When the infuser is operating under the DDL, the entire range is available within each dosing unit, for every drug. When a custom drug library is installed, the input ranges are determined by the hard and soft limits assigned to each drug.

**NOTE:** Dosing units shown in bold italics are applicable to software version 15.1 and later.

Category	Dosing Units	Range	Increment
<b>grams</b>	mcg, mg, g, mcg/min, mcg/hr, mcg/day, mcg/kg, mcg/kg/min, mcg/kg/hr, mcg/kg/day, mcg/m <sup>2</sup> , mcg/m <sup>2</sup> /min, mcg/m <sup>2</sup> /hr, mcg/m <sup>2</sup> /day, mg/min, mg/hr, mg/day, mg/kg, mg/kg/min, mg/kg/hr, mg/ kg/day, mg/m <sup>2</sup> , mg/m <sup>2</sup> /min, mg/m <sup>2</sup> /hr, mg/m <sup>2</sup> /day, grams/min, grams/hr, grams/day, grams/kg, grams/kg/min, grams/kg/hr, grams/kg/day, grams/m <sup>2</sup> , grams/ m <sup>2</sup> /hr, grams/m <sup>2</sup> /day, grams/m <sup>2</sup> /min, <i><b>nanog</b></i> , nanog/min, nanog/hr, nanog/day, <i><b>nanog/kg</b></i> , nanog/kg/min, nanog/kg/hr, nanog/kg/day, <i><b>nanog/m<sup>2</sup></b></i> , nanog/m <sup>2</sup> /min, nanog/m <sup>2</sup> /hr, nanog/m <sup>2</sup> /day	0.001-9.999	0.001
		10.00-99.99	0.01
		100-9999	1



Category	Dosing Units	Range	Increment
<b>Liters</b>	liters/m <sup>2</sup> /day, liters/m <sup>2</sup> /hr, liters/m <sup>2</sup> /min	0.001-9.999	0.001
		10.00-99.99	0.01
		100-99999	1
<b>mEq</b>	<b>mEq</b> , mEq/min, mEq/hr, mEq/day, <b>mEq/kg</b> , mEq/kg/min, mEq/kg/hr, mEq/kg/day, <b>mEq/m<sup>2</sup></b> , mEq/m <sup>2</sup> /min, mEq/m <sup>2</sup> /hr, mEq/m <sup>2</sup> /day	0.001-0.999	0.001
		1.00-9.99	0.01
		10.0-99.9	0.1
		100-99999	1
<b>mL</b>	mL/hr	0.1-99.9	0.1
		100-999	1
	mL, mL/min, mL/kg, mL/kg/min, mL/kg/hr, mL/kg/day, <b>mL/m<sup>2</sup></b> , mL/m <sup>2</sup> /hr, mL/m <sup>2</sup> /min, mL/m <sup>2</sup> /day	0.001-9.999	0.001
		10.00-99.99	0.01
		100-99999	1
<b>mmol</b>	<b>mmol</b> , mmol/min, mmol/hr, mmol/day, mmol/kg, mmol/kg/min, mmol/kg/hr, mmol/ kg/day, <b>mmol/m<sup>2</sup></b> , <b>mmol/m<sup>2</sup>/min</b> , <b>mmol/m<sup>2</sup>/hr</b> , <b>mmol/m<sup>2</sup>/day</b>	0.001-0.999	0.001
		1.00-9.99	0.01
		10.0-99.9	0.1
		100-999	1
<b>Units</b>	<b>milliUnits</b> , milliUnits/min, milliUnits/hr, milliUnits/day, milliUnits/kg, milliUnits/kg/min, milliUnits/kg/hr, milliUnits/kg/day, <b>milliUnits/m<sup>2</sup></b> , milliUnits/m <sup>2</sup> /min, milliUnits/m <sup>2</sup> /hr, milliUnits/m <sup>2</sup> /day  <b>units</b> , units/min, units/hr, units/day, units/kg, units/kg/min, units/kg/hr, units/kg/day, units/m <sup>2</sup> , units/m <sup>2</sup> /min, units/m <sup>2</sup> /hr, units/m <sup>2</sup> /day	0.001-0.999	0.001
		1.00-9.99	0.01
		10.0-99.9	0.1
		100- 999999999	1

Category	Dosing Units	Range	Increment
Million Units	<i>Million Units, Million Units/kg, Million Units/kg/min, Million Units/kg/hr, Million Units/min, Million Units/hr, Million Units/m<sup>2</sup>, Million Units/m<sup>2</sup>/min, Million Units/m<sup>2</sup>/hr</i>	0.001-0.999	0.001
		1.00-9.99	0.01
		10.0-99.9	0.1
		100-999	1

## Patient Data Limits

When you program a delivery for a weight-based dosage (mg/kg/hr, for example), you must enter the patient's weight. When programming a BSA (Body Surface Area)-based delivery (grams/m<sup>2</sup>/min, for example), you must enter either the patient's height and weight, or enter the BSA directly.

**NOTE:** If you enter the height and weight, the BSA is computed using the DuBois method.

The following table shows the valid ranges for patient weight, height, and BSA, and the increments for each range.

Patient Data	Range	Increment
Weight (kg)	0.100 to 9.999	0.001
	10.00 to 99.99	0.01
	100.0 to 500.0	0.1
Height (cm)	7.5 to 305.0	0.1
BSA (m <sup>2</sup> )	0.012 to 0.999	0.001
	1.00 to 7.07	0.01

For more information about dose calculations, see [Programming](#) on page 5-1.

For more information about BSA-based deliveries, see [Body Surface Area \(BSA\) Dosing Unit](#) on page 5-1.

## United States

For customer service, contact:

**1-877-946-7747**

For technical assistance, product return authorization, and to order parts or manuals, contact ICU Medical Technical Support Center:

**1-800-241-4002**

Parts orders can be submitted by email:

**[TSC.Parts@icumed.com](mailto:TSC.Parts@icumed.com)**

or by fax:

**1-408-284-7130**

To review replacement parts lists, technical service manuals, and alternative cleaning agents, or for additional technical resources, operating manuals, and technical training courses, visit:

**[www.icumed.com](http://www.icumed.com)**

For inquiries on reprocessing (cleaning/disinfecting), email  
Tech Support Client Solution Specialists at:

**[TSC.Support@icumed.com](mailto:TSC.Support@icumed.com)**

## Canada

For customer service, contact the Pump Repair Center:

**1-866-488-6088**

or by email:

**[canadapumpsupport@icumed.com](mailto:canadapumpsupport@icumed.com)**

To order parts, contact Spare Parts Customer Service:

**1-866-488-6088**

or by email:

**[pumppartsservices@icumed.com](mailto:pumppartsservices@icumed.com)**

## All Other Countries

For technical assistance, contact your local ICU Medical sales office.



### CAUTION

**FEDERAL (USA) LAW RESTRICTS THIS INFUSER TO SALE BY OR ON THE ORDER OF A PHYSICIAN OR OTHER LICENSED PRACTITIONER.**



### WARNING

**POSSIBLE EXPLOSION HAZARD EXISTS IF THE INFUSER IS USED IN THE PRESENCE OF FLAMMABLE SUBSTANCES, INCLUDING ANESTHETICS.**

CE 2797



MD

EC REP

ICU Medical B.V.  
Hofspoor 3, 3994 VZ Houten,  
The Netherlands



ICU Medical, Inc.  
600 N. Field Drive  
Lake Forest, Illinois, 60045  
USA

Australian Sponsor: ICU Medical Australia Pty Limited  
Unit U, 10-16 South Street,  
Rydalmere, NSW 2116  
Australia